

# G25<sup>®</sup>



WYSOKIEJ JAKOŚCI NARZĘDZIA  
DLA PRZEMYSŁU

G25 to grupa polskich firm, które łączy:

1. ponad **25-letnie** doświadczenie w obsłudze przemysłu w Polsce,
2. ponad **25-letnie** know-how w handlu w branży narzędziowej.

Działając w różnych regionach Polski budujemy lokalne, partnerskie relacje z Klientami, zapewniając standardy jakości narzędzi i obsługi na najwyższym poziomie.

Produkty G25 to starannie wyselekcjonowane narzędzia, które produkują dla nas, według najwyższych standardów, firmy krajowe i zagraniczne. Wybór został dokonany w oparciu o nasze doświadczenie handlowe i produkcyjne oraz opinie techniczne zaufanych użytkowników z branż samochodowej, stoczniowej czy lotniczej, pod kątem potrzeb naszych Klientów.

Naszym Klientom i Partnerom oferujemy również usługi:

- **systemy filtracji:** mgły olejowej, cieczy przemysłowych i magnetycznej
- **systemy usprawniania gospodarki narzędziowej** w formie automatów wydających
- **usługi profesjonalne w postaci:** szkoleń, wdrożeń systemów jakości, usprawnień procesów produkcyjnych i pomiarowych, wzorcowań przyrządów pomiarowych oraz pomiarów elementów geometrycznych

G25 to 25 lat doświadczenia, by przyszłość należała do Was.

Legenda	4
Wiertła HSS-G (NWKa)	5
Wiertła HSSE	6
Wiertła HSSE INOX	7
Wiertła HSS (NWKc)	8
Wiertła VHM 3D i 5D	9
Wiertła rurowe	10
Nawiertaki	10
Pogłębiacze stożkowe	11
Rozwiertaki	12
Frezy VHM	13-17
Frezy VHM Expert Line	18
Frezy VHM zalecane parametry skrawania	19-20
Pilniki obrotowe	21
Gwintowniki maszynowe	22-25
Narzynki	26-27
Gwintowniki maszynowe, narzynki zalecane parametry skrawania	28-29
Sprawdziany gwintowe trzępieniowe i pierścieniowe	30-33
Głowice frezarskie	34-35
Płytki wielostrzowe frezarskie	36
Szafy wydające	37
Szczęki miękkie	38-41
Torby dla monterów i elektryków	42
Materiały ścierne	43
Rękawice spawalnicze	43
Filtracja	44-45
Technika pomiarowa	46-50
Profesjonalne usługi pomiarowe	51

1. Materiał obrabiany

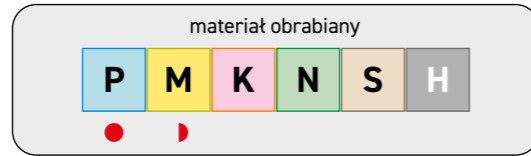

- ISO P - stal
- ISO M - stale nierdzewne
- ISO K - żeliwo
- ISO N - metale nieżelazne
- ISO S - superstopy żaroodporne
- ISO H - stal hartowana
- zalecany
- dopuszczalny

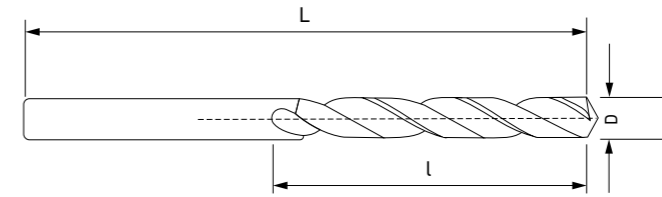

HSS-G DIN 338 135° N

2. Materiał części skrawającej

- HSS: stal szybko tnąca standardowa
- HSS-G: stal szybko tnąca szlifowana
- HSSE: stal szybko tnąca z zawartością kobaltu
- HSSCo5
- VHM: narzędzia pełnowęglkowe
- HSS-PM: stal proszkowa szybko tnąca z zawartością kobaltu

3. Norma ISO

- DIN 338: wiertło kręte z chwytem cylindrycznym
- DIN 345: wiertło kręte ze stożkiem Morse'a
- DIN 6535HA: chwyt walcowy gładki HA
- DIN 333A: narzędzie wykonane według normy DIN 333
- DIN 371: narzędzie wykonane według normy DIN 371
- DIN 376: narzędzie wykonane według normy DIN 376
- DIN 374: narzędzie wykonane według normy DIN 374

4. Powłoki

- TiAlN: azotek tytanu aluminium
- TiN: azotek tytanu
- TN: TiAlN + TiN
- HL: TiAlN + WC/C
- TCN: TiN + TiCN
- ATN: AlTiN
- HC: pokrywane
- HW: niepokrywane
- OX: powłoka oksydowana

5. Oznaczenia dodatkowe

- 5xD: długość części roboczej
- 118°: kąt ostrza
- 25-30°: zakres kąta pochylenia linii śrubowej
- IK: chłodzenie wewnętrzne
- uchwyt walcowy
- WK: wiertło kręte
- 60°: kąt pogłębienia
- stożek Morse'a
- N: typ N - skrawanie materiałów o normalnej wytrzymałości i twardości
- Ti: typ Ti - skrawanie stali twardych, nierdzewnych, kwasoodpornych, dla szczególnie twardych materiałów i przy wierceniu głębokich otworów
- 35°: kąt pochylenia linii śrubowej
- Z=4: liczba ostrzy tnących
- Z=3: liczba ostrzy tnących

KOD PRODUKTU	D (mm)	L (mm)	l (mm)	KOD PRODUKTU	D (mm)	L (mm)	l (mm)	KOD PRODUKTU	D (mm)	L (mm)	l (mm)
MG338000S0-0100	1.0	34	12	MG338000S0-0520	5.2	86	52	MG338000S0-0940	9.4	125	81
MG338000S0-0110	1.1	36	14	MG338000S0-0530	5.3	86	52	MG338000S0-0950	9.5	125	81
MG338000S0-0120	1.2	38	16	MG338000S0-0540	5.4	93	57	MG338000S0-0960	9.6	133	87
MG338000S0-0130	1.3	38	16	MG338000S0-0550	5.5	93	57	MG338000S0-0970	9.7	133	87
MG338000S0-0140	1.4	40	18	MG338000S0-0560	5.6	93	57	MG338000S0-0980	9.8	133	87
MG338000S0-0150	1.5	40	18	MG338000S0-0570	5.7	93	57	MG338000S0-0990	9.9	133	87
MG338000S0-0160	1.6	43	20	MG338000S0-0580	5.8	93	57	MG338000S0-1000	10.0	133	87
MG338000S0-0170	1.7	43	20	MG338000S0-0590	5.9	93	57	MG338000S0-1020	10.2	133	87
MG338000S0-0180	1.8	46	22	MG338000S0-0600	6.0	93	57	MG338000S0-1050	10.5	133	87
MG338000S0-0190	1.9	46	22	MG338000S0-0610	6.1	101	63	MG338000S0-1100	11.0	142	94
MG338000S0-0200	2.0	49	24	MG338000S0-0620	6.2	101	63	MG338000S0-1150	11.5	142	94
MG338000S0-0210	2.1	49	24	MG338000S0-0630	6.3	101	63	MG338000S0-1200	12.0	151	101
MG338000S0-0220	2.2	53	27	MG338000S0-0640	6.4	101	63	MG338000S0-1250	12.5	151	101
MG338000S0-0230	2.3	53	27	MG338000S0-0650	6.5	101	63	MG338000S0-1300	13.0	151	101
MG338000S0-0240	2.4	57	30	MG338000S0-0660	6.6	101	63	MG338000S0-1350	13.5	160	108
MG338000S0-0250	2.5	57	30	MG338000S0-0670	6.7	101	63	MG338000S1-1350	13.5R*	160	108
MG338000S0-0260	2.6	57	30	MG338000S0-0680	6.8	109	69	MG338000S0-1400	14.0	160	108
MG338000S0-0270	2.7	61	33	MG338000S0-0690	6.9	109	69	MG338000S1-1400	14.0R	160	108
MG338000S0-0280	2.8	61	33	MG338000S0-0700	7.0	109	69	MG338000S0-1450	14.5	169	114
MG338000S0-0290	2.9	61	33	MG338000S0-0710	7.1	109	69	MG338000S1-1450	14.5R	169	114
MG338000S0-0300	3.0	61	33	MG338000S0-0720	7.2	109	69	MG338000S0-1500	15.0	169	114
MG338000S0-0310	3.1	65	36	MG338000S0-0730	7.3	109	69	MG338000S1-1500	15.0R	169	114
MG338000S0-0320	3.2	65	36	MG338000S0-0740	7.4	109	69	MG338000S0-1550	15.5	178	120
MG338000S0-0330	3.3	65	36	MG338000S0-0750	7.5	109	69	MG338000S1-1550	15.5R	178	120
MG338000S0-0340	3.4	70	39	MG338000S0-0760	7.6	117	75	MG338000S0-1600	16.0	178	120
MG338000S0-0350	3.5	70	39	MG338000S0-0770	7.7	117	75	MG338000S1-1600	16.0R	178	120
MG338000S0-0360	3.6	70	39	MG338000S0-0780	7.8	117	75	MG338000S0-1650	16.5	178	120
MG338000S0-0370	3.7	70	39	MG338000S0-0790	7.9	117	75	MG338000S1-1650	16.5R	178	120
MG338000S0-0380	3.8	75	43	MG338000S0-0800	8.0	117	75	MG338000S0-1700	17.0	178	120
MG338000S0-0390	3.9	75	43	MG338000S0-0810	8.1	117	75	MG338000S1-1700	17.0R	178	120
MG338000S0-0400	4.0	75	43	MG338000S0-0820	8.2	117	75	MG338000S0-1750	17.5	191	130
MG338000S0-0410	4.1	75	43	MG338000S0-0830	8.3	117	75	MG338000S1-1750	17.5R	191	130
MG338000S0-0420	4.2	75	43	MG338000S0-0840	8.4	117	75	MG338000S0-1800	18.0	191	130
MG338000S0-0430	4.3	80	47	MG338000S0-0850	8.5	117	75	MG338000S1-1800	18.0R	191	130
MG338000S0-0440	4.4	80	47	MG338000S0-0860	8.6	125	81	MG338000S0-1850	18.5	198	135
MG338000S0-0450	4.5	80	47	MG338000S0-0870	8.7	125	81	MG338000S1-1850	18.5R	198	135
MG338000S0-0460	4.6	80	47	MG338000S0-0880	8.8	125	81	MG338000S0-1900	19.0	198	135
MG338000S0-0470	4.7	80	47	MG338000S0-0890	8.9	125	81	MG338000S1-1900	19.0R	198	135
MG338000S0-0480	4.8	86	52	MG338000S0-0900	9.0	125	81	MG338000S0-1950	19.5	205	140
MG338000S0-0490	4.9	86	52	MG338000S0-0910	9.1	125	81	MG338000S1-1950	19.5R	205	140
MG338000S0-0500	5.0	86	52	MG338000S0-0920	9.2	125	81	MG338000S0-2000	20.0	205	140
MG338000S0-0510	5.1	86	52	MG338000S0-0930	9.3	125	81	MG338000S1-2000	20.0R	205	140

**Dodatkowo:**  
Komplet wiertel M25 NWKa 1.0-13.0 HSS-G szlifowane PROFIL G25  
kod katalogowy: MG338000S0-M25/25 sztuk

Komplet wiertel M19 NWKa 1.0-10.0 HSS-G szlifowane PROFIL G25  
kod katalogowy: MG338000S0-M19/19 sztuk

R\* - redukcja chwytu do 13 mm

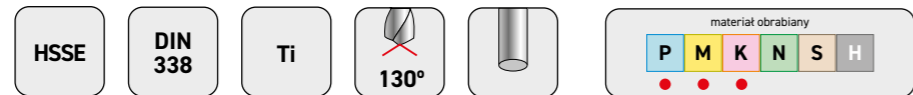
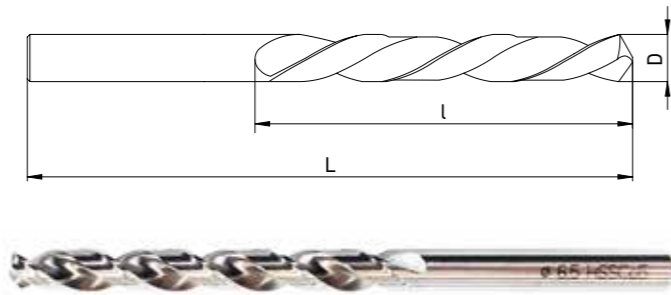

KOD PRODUKTU	D (mm)	L (mm)	l (mm)
MG33801000-0100	1.0	34	12
MG33801000-0110	1.1	36	14
MG33801000-0120	1.2	38	16
MG33801000-0130	1.3	38	16
MG33801000-0140	1.4	40	18
MG33801000-0150	1.5	40	18
MG33801000-0160	1.6	43	20
MG33801000-0170	1.7	43	20
MG33801000-0180	1.8	46	22
MG33801000-0190	1.9	46	22
MG33801000-0200	2.0	49	24
MG33801000-0210	2.1	49	24
MG33801000-0220	2.2	53	27
MG33801000-0230	2.3	53	27
MG33801000-0240	2.4	57	30
MG33801000-0250	2.5	57	30
MG33801000-0260	2.6	57	30
MG33801000-0270	2.7	61	33
MG33801000-0280	2.8	61	33
MG33801000-0290	2.9	61	33
MG33801000-0300	3.0	61	33
MG33801000-0310	3.1	65	36
MG33801000-0320	3.2	65	36
MG33801000-0330	3.3	65	36
MG33801000-0340	3.4	70	39
MG33801000-0350	3.5	70	39
MG33801000-0360	3.6	70	39
MG33801000-0370	3.7	70	39
MG33801000-0380	3.8	75	43
MG33801000-0390	3.9	75	43
MG33801000-0400	4.0	75	43
MG33801000-0410	4.1	75	43
MG33801000-0420	4.2	75	43
MG33801000-0430	4.3	80	47
MG33801000-0440	4.4	80	47
MG33801000-0450	4.5	80	47
MG33801000-0460	4.6	80	47
MG33801000-0470	4.7	80	47
MG33801000-0480	4.8	86	52
MG33801000-0490	4.9	86	52
MG33801000-0500	5.0	86	52
MG33801000-0510	5.1	86	52

KOD PRODUKTU	D (mm)	L (mm)	l (mm)
MG33801000-0520	5.2	86	52
MG33801000-0530	5.3	86	52
MG33801000-0540	5.4	93	57
MG33801000-0550	5.5	93	57
MG33801000-0560	5.6	93	57
MG33801000-0570	5.7	93	57
MG33801000-0580	5.8	93	57
MG33801000-0590	5.9	93	57
MG33801000-0600	6.0	93	57
MG33801000-0610	6.1	101	63
MG33801000-0620	6.2	101	63
MG33801000-0630	6.3	101	63
MG33801000-0640	6.4	101	63
MG33801000-0650	6.5	101	63
MG33801000-0660	6.6	101	63
MG33801000-0670	6.7	101	63
MG33801000-0680	6.8	109	69
MG33801000-0690	6.9	109	69
MG33801000-0700	7.0	109	69
MG33801000-0710	7.1	109	69
MG33801000-0720	7.2	109	69
MG33801000-0730	7.3	109	69
MG33801000-0740	7.4	109	69
MG33801000-0750	7.5	109	69
MG33801000-0760	7.6	117	75
MG33801000-0770	7.7	117	75
MG33801000-0780	7.8	117	75
MG33801000-0790	7.9	117	75
MG33801000-0800	8.0	117	75
MG33801000-0810	8.1	117	75
MG33801000-0820	8.2	117	75
MG33801000-0830	8.3	117	75
MG33801000-0840	8.4	117	75
MG33801000-0850	8.5	117	75
MG33801000-0860	8.6	125	81
MG33801000-0870	8.7	125	81
MG33801000-0880	8.8	125	81
MG33801000-0890	8.9	125	81
MG33801000-0900	9.0	125	81
MG33801000-0910	9.1	125	81
MG33801000-0920	9.2	125	81
MG33801000-0930	9.3	125	81

KOD PRODUKTU	D (mm)	L (mm)	l (mm)
MG33801000-0940	9.4	125	81
MG33801000-0950	9.5	125	81
MG33801000-0960	9.6	133	87
MG33801000-0970	9.7	133	87
MG33801000-0980	9.8	133	87
MG33801000-0990	9.9	133	87
MG33801000-1000	10.0	133	87
MG33801000-1020	10.2	133	87
MG33801000-1050	10.5	133	87
MG33801000-1100	11.0	142	94
MG33801000-1150	11.5	142	94
MG33801000-1200	12.0	151	101
MG33801000-1250	12.5	151	101
MG33801000-1300	13.0	151	101
MG33801000-1350	13.5	160	108
MG33801001-1350	13.5R*	160	108
MG33801000-1400	14.0	160	108
MG33801001-1400	14.0R	160	108
MG33801000-1450	14.5	169	114
MG33801001-1450	14.5R	169	114
MG33801000-1500	15.0	169	114
MG33801001-1500	15.0R	169	114
MG33801000-1550	15.5	178	120
MG33801001-1550	15.5R	178	120
MG33801000-1600	16.0	178	120
MG33801001-1600	16.0R	178	120
MG33801000-1650	16.0	178	120
MG33801001-1650	16.0R	178	120
MG33801000-1700	17.0	178	120
MG33801001-1700	17.0R	178	120
MG33801000-1750	17.5	191	130
MG33801001-1750	17.5R	191	130
MG33801000-1800	18.0	191	130
MG33801001-1800	18.0R	191	130
MG33801000-1850	18.5	198	135
MG33801001-1850	18.5R	198	135
MG33801000-1900	19.0	198	135
MG33801001-1900	19.0R	198	135
MG33801000-1950	19.5	205	140
MG33801001-1950	19.5R	205	140
MG33801000-2000	20.0	205	140
MG33801001-2000	20.0R	205	140

R\* - redukcja chwytu do 13 mm

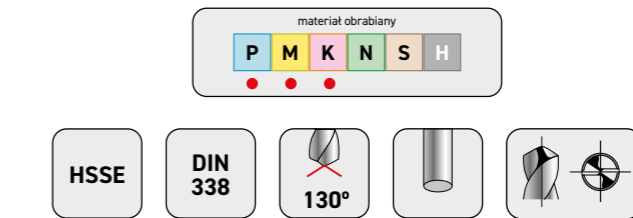
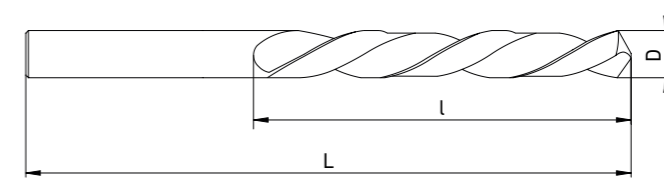

Expert Line

KOD PRODUKTU	D (mm)	L (mm)	l (mm)
MG338010SI-0100	1.0	34	12
MG338010SI-0150	1.5	40	18
MG338010SI-0200	2.0	49	24
MG338010SI-0250	2.5	57	30
MG338010SI-0300	3.0	61	33
MG338010SI-0330	3.3	65	36
MG338010SI-0350	3.5	70	39
MG338010SI-0400	4.0	75	43
MG338010SI-0420	4.2	75	43
MG338010SI-0450	4.5	80	47
MG338010SI-0500	5.0	86	52
MG338010SI-0550	5.5	93	57
MG338010SI-0600	6.0	93	57
MG338010SI-0650	6.5	101	63
MG338010SI-0680	6.8	109	69
MG338010SI-0700	7.0	109	69
MG338010SI-0750	7.5	109	69
MG338010SI-0800	8.0	117	75
MG338010SI-0850	8.5	117	75
MG338010SI-0900	9.0	125	81
MG338010SI-0950	9.5	125	81
MG338010SI-1000	10.0	133	87
MG338010SI-1020	10.2	133	87
MG338010SI-1050	10.5	133	87
MG338010SI-1100	11.0	142	94
MG338010SI-1150	11.5	142	94
MG338010SI-1200	12.0	151	101
MG338010SI-1250	12.5	151	101
MG338010SI-1300	13.0	151	101



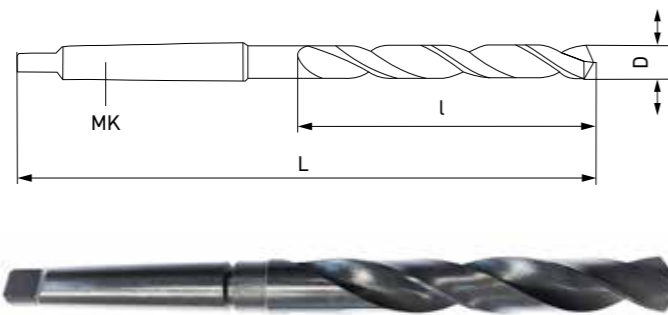

HSS
DIN 345
118°
N
materiał obrabiany: P M K N S H

KOD PRODUKTU	D (mm)	L (mm)	l (mm)	
MG34500000-0500	5.0	133	52	1
MG34500000-0550	5.5	138	57	1
MG34500000-0600	6.0	138	57	1
MG34500000-6500	6.5	144	63	1
MG34500000-0680	6.8	150	69	1
MG34500000-0700	7.0	150	69	1
MG34500000-0750	7.5	150	69	1
MG34500000-0800	8.0	156	75	1
MG34500000-0850	8.5	156	75	1
MG34500000-0900	9.0	162	81	1
MG34500000-0950	9.5	162	81	1
MG34500000-1000	10.0	168	87	1
MG34500000-1020	10.2	168	87	1
MG34500000-1050	10.5	168	87	1
MG34500000-1100	11.0	175	94	1
MG34500000-1150	11.5	175	94	1
MG34500000-1200	12.0	182	101	1
MG34500000-1250	12.5	182	101	1
MG34500000-1300	13.0	182	101	1
MG34500000-1350	13.5	189	108	1
MG34500000-1400	14.0	189	108	1
MG34500000-1450	14.5	212	114	2
MG34500000-1500	15.0	212	114	2
MG34500000-1550	15.5	218	120	2
MG34500000-1600	16.0	218	120	2
MG34500000-1650	16.5	223	125	2
MG34500000-1700	17.0	223	125	2
MG34500000-1750	17.5	228	130	2
MG34500000-1800	18.0	228	130	2
MG34500000-1850	18.5	233	135	2
MG34500000-1900	19.0	233	135	2
MG34500000-1950	19.5	238	140	2
MG34500000-2000	20.0	238	140	2
MG34500000-2050	20.5	243	145	2
MG34500000-2100	21.0	243	145	2
MG34500000-2150	21.5	248	150	2
MG34500000-2200	22.0	248	150	2
MG34500000-2250	22.5	253	155	2
MG34500000-2300	23.0	253	155	2
MG34500000-2350	23.5	253	155	3
MG34500000-2400	24.0	281	160	3
MG34500000-2450	24.5	281	160	3
MG34500000-2500	25.0	281	160	3
MG34500000-2550	25.5	286	165	3
MG34500000-2600	26.0	286	165	3
MG34500000-2650	26.5	286	165	3
MG34500000-2700	27.0	291	170	3

KOD PRODUKTU	D (mm)	L (mm)	l (mm)	
MG34500000-2750	27.5	291	170	3
MG34500000-2800	28.0	291	170	3
MG34500000-2850	28.5	296	175	3
MG34500000-2900	29.0	296	175	3
MG34500000-2950	29.5	296	175	3
MG34500000-3000	30.0	296	175	3
MG34500000-3050	30.5	301	180	3
MG34500000-3100	31.0	301	180	3
MG34500000-3150	31.5	301	180	3
MG34500000-3200	32.0	334	185	4
MG34500000-3250	32.5	334	185	4
MG34500000-3300	33.0	334	185	4
MG34500000-3350	33.5	334	185	4
MG34500000-3400	34.0	339	190	4
MG34500000-3450	34.5	339	190	4
MG34500000-3500	35.0	339	190	4
MG34500000-3550	35.5	339	190	4
MG34500000-3600	36.0	344	195	4
MG34500000-3650	36.5	344	195	4
MG34500000-3700	37.0	344	195	4
MG34500000-3750	37.5	344	195	4
MG34500000-3800	38.0	349	200	4
MG34500000-3850	38.5	349	200	4
MG34500000-3900	39.0	349	200	4
MG34500000-3950	39.5	349	200	4
MG34500000-4000	40.0	349	200	4
MG34500000-4050	40.5	354	205	4
MG34500000-4100	41.0	354	205	4
MG34500000-4150	41.5	354	205	4
MG34500000-4200	42.0	354	205	4
MG34500000-4250	42.5	354	205	4
MG34500000-4300	43.0	359	210	4
MG34500000-4350	43.5	359	210	4
MG34500000-4400	44.0	359	210	4
MG34500000-4450	44.5	359	210	4
MG34500000-4500	45.0	359	210	4
MG34500000-4550	45.5	364	215	4
MG34500000-4600	46.0	364	215	4
MG34500000-4650	46.5	364	215	4
MG34500000-4700	47.0	364	215	4
MG34500000-4750	47.5	364	215	4
MG34500000-4800	48.0	369	220	4
MG34500000-4850	48.5	369	220	4
MG34500000-4900	49.0	369	220	4
MG34500000-4950	49.5	369	220	4
MG34500000-5000	50.0	369	220	4

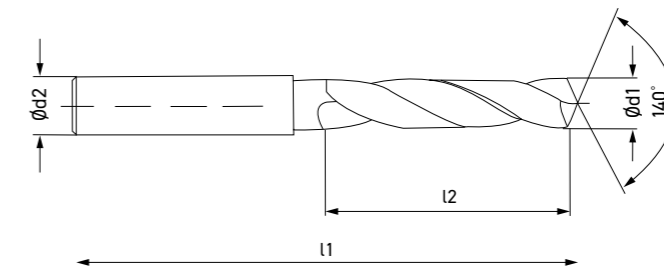

VHM
DIN 6537
ATN
HRC <44
IK
WK
materiał obrabiany: P M K N S H

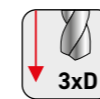

Expert Line

KOD PRODUKTU	d1 (mm)	l1 (mm)	l2 (mm)	Ød2h6 (mm)
MG65374613-0300	3.0	62	20	6.0
MG65374613-0320	3.2	62	20	6.0
MG65374613-0330	3.3	62	20	6.0
MG65374613-0370	3.7	62	20	6.0
MG65374613-0380	3.8	66	24	6.0
MG65374613-0400	4.0	66	24	6.0
MG65374613-0420	4.2	66	24	6.0
MG65374613-0430	4.3	66	24	6.0
MG65374613-0450	4.5	66	24	6.0
MG65374613-0500	5.0	66	28	6.0
MG65374613-0520	5.2	66	28	6.0
MG65374613-0550	5.5	66	28	6.0
MG65374613-0600	6.0	66	28	6.0
MG65374613-0650	6.5	79	34	8.0
MG65374613-0680	6.8	79	34	8.0
MG65374613-0700	7.0	79	34	8.0
MG65374613-0745	7.45	79	41	8.0
MG65374613-0760	7.6	79	41	8.0
MG65374613-0780	7.8	79	41	8.0
MG65374613-0800	8.0	79	41	8.0
MG65374613-0850	8.5	89	47	10.0
MG65374613-0900	9.0	89	47	10.0
MG65374613-0935	9.35	89	47	10.0
MG65374613-0950	9.5	89	47	10.0
MG65374613-0980	9.8	89	47	10.0
MG65374613-1000	10.0	89	47	10.0
MG65374613-1020	10.2	102	55	12.0
MG65374613-1050	10.5	102	55	12.0
MG65374613-1100	11.0	102	55	12.0
MG65374613-1150	11.5	102	55	12.0
MG65374613-1180	11.8	102	55	12.0
MG65374613-1200	12.0	102	55	12.0
MG65374613-1250	12.5	107	60	14.0
MG65374613-1300	13.0	107	60	14.0
MG65374613-1350	13.5	107	60	14.0
MG65374613-1400	14.0	107	60	14.0
MG65374613-1450	14.5	115	65	16.0
MG65374613-1500	15.0	115	65	16.0
MG65374613-1580	15.8	115	65	16.0
MG65374613-1600	16.0	115	65	16.0
MG65374613-1700	17.0	123	73	18.0
MG65374613-1800	18.0	123	73	18.0

Inne rozmiary dostępne na zapytanie



Expert Line

KOD PRODUKTU	d1 (mm)	l1 (mm)	l2 (mm)	Ød2h6 (mm)
MG65374615-0300	3.0	66	28	6.0
MG65374615-0320	3.2	66	28	6.0
MG65374615-0330	3.3	66	28	6.0
MG65374615-0370	3.7	66	28	6.0
MG65374615-0380	3.8	74	36	6.0
MG65374615-0400	4.0	74	36	6.0
MG65374615-0420	4.2	74	36	6.0
MG65374615-0430	4.3	74	36	6.0
MG65374615-0450	4.5	74	36	6.0
MG65374615-0500	5.0	82	44	6.0
MG65374615-0520	5.2	82	44	6.0
MG65374615-0550	5.5	82	44	6.0
MG65374615-0560	5.6	82	44	6.0
MG65374615-0600	6.0	82	44	6.0
MG65374615-0650	6.5	91	53	8.0
MG65374615-0680	6.8	91	53	8.0
MG65374615-0700	7.0	91	53	8.0
MG65374615-0745	7.45	91	53	8.0
MG65374615-0760	7.6	91	53	8.0
MG65374615-0780	7.8	91	53	8.0
MG65374615-0800	8.0	91	53	8.0
MG65374615-0850	8.5	103	61	10.0
MG65374615-0900	9.0	103	61	10.0
MG65374615-0950	9.5	103	61	10.0
MG65374615-0980	9.8	103	61	10.0
MG65374615-1000	10.0	103	61	10.0
MG65374615-1020	10.2	118	71	12.0
MG65374615-1050	10.5	118	71	12.0
MG65374615-1100	11.0	118	71	12.0
MG65374615-1150	11.5	118	71	12.0
MG65374615-1180	11.8	118	71	12.0
MG65374615-1200	12.0	118	71	12.0
MG65374615-1250	12.5	124	77	14.0
MG65374615-1300	13.0	124	77	14.0
MG65374615-1350	13.5	124	77	14.0
MG65374615-1400	14.0	124	77	14.0
MG65374615-1450	14.5	133	83	16.0
MG65374615-1500	15.0	133	83	16.0
MG65374615-1580	15.8	133	83	16.0
MG65374615-1600	16.0	133	83	16.0
MG65374615-1700	17.0	143	93	18.0
MG65374615-1800	18.0	143	93	18.0

Inne rozmiary dostępne na zapytanie

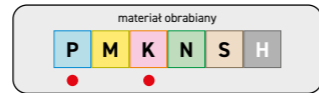

KOD PRODUKTU	nazwa
MGOTWT0025-1200	12x25 HSS
MGOTWT0025-1300	13x25 HSS
MGOTWT0025-1400	14x25 HSS
MGOTWT0025-1500	15x25 HSS
MGOTWT0025-1600	16x25 HSS
MGOTWT0025-1700	17x25 HSS
MGOTWT0025-1800	18x25 HSS
MGOTWT0025-1900	19x25 HSS
MGOTWT0025-2000	20x25 HSS
MGOTWT0025-2100	21x25 HSS
MGOTWT0025-2200	22x25 HSS
MGOTWT0025-2300	23x25 HSS
MGOTWT0025-2400	24x25 HSS
MGOTWT0025-2500	25x25 HSS
MGOTWT0025-2600	26x25 HSS
MGOTWT0025-2700	27x25 HSS

KOD PRODUKTU	nazwa
MGOTWT0025-2800	28x25 HSS
MGOTWT0025-2900	29x25 HSS
MGOTWT0025-3000	30x25 HSS
MGOTWT0025-3100	31x25 HSS
MGOTWT0025-3200	32x25 HSS
MGOTWT0025-3300	33x25 HSS
MGOTWT0025-3400	34x25 HSS
MGOTWT0025-3500	35x25 HSS
MGOTWT0025-3600	36x25 HSS
MGOTWT0025-3700	37x25 HSS
MGOTWT0025-3800	38x25 HSS
MGOTWT0025-3900	39x25 HSS
MGOTWT0025-4000	40x25 HSS
MGOTWT0025-4500	45x25 HSS
MGOTWT0025-5000	50x25 HSS
MGOTWT0025-PILO	Pilot do w.rurowych 25mm 6.34x77

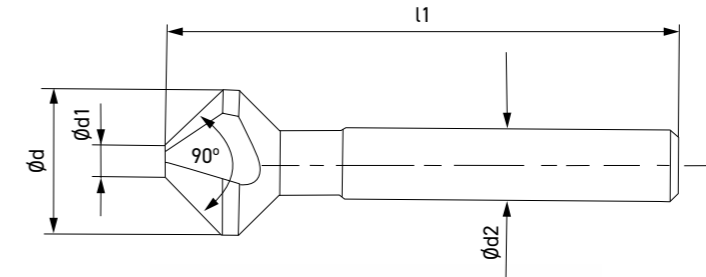

KOD PRODUKTU	d	d1	d2	l1
<b>HSSE TCN Expert Line</b>				
MG335C2500-0630	6.3	1.5	5	45
MG335C2500-0830	8.3	2.0	6	50
MG335C2500-1040	10.4	2.5	6	50
MG335C2500-1240	12.4	2.8	8	56
MG335C2500-1650	16.5	3.2	10	60
MG335C2500-2050	20.5	3.5	10	63
MG335C2500-2500	25.0	3.8	10	67
MG335C2500-3000	30.0	4.2	12	71

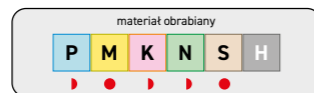
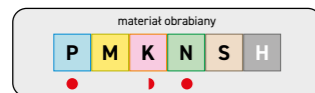
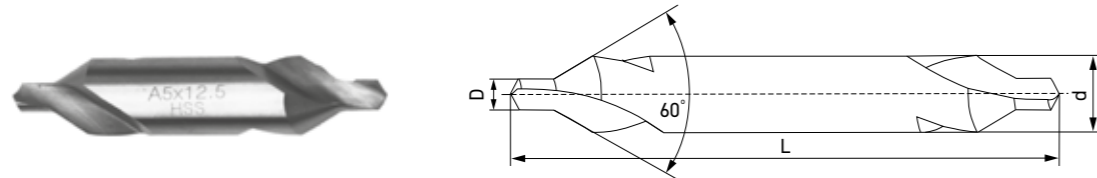

KOD PRODUKTU		D	d	L
HSS	HSSE	(mm)	(mm)	(mm)
MG333A0000-0100	MG333A1000-0100	1,00	3,15	31,5
MG333A0000-0125		1,25	3,15	31,5
MG333A0000-0160	MG333A1000-0160	1,60	4,00	35,5
MG333A0000-0200	MG333A1000-0200	2,00	5,00	40,0
MG333A0000-0250	MG333A1000-0250	2,50	6,30	45,0
MG333A0000-0315	MG333A1000-0315	3,15	8,00	50,0
MG333A0000-0400	MG333A1000-0400	4,00	10,00	56,0
MG333A0000-0500	MG333A1000-0500	5,00	12,50	63,0
MG333A0000-0630	MG333A1000-0630	6,30	16,00	71,0
MG333A0000-0800		8,00	20,00	80,0
MG333A0000-1000		10,00	25,00	100,0

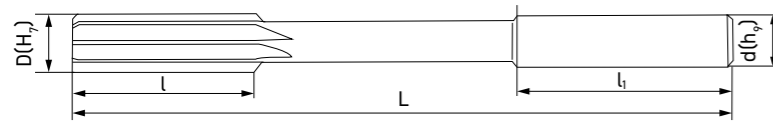

KOD PRODUKTU	DIN	D	d	l	l1	L	Z
MG212A1000-0300	212-A	3	3	15	-	61	6
MG212C1000-0400		4	4	19	32	75	6
MG212C1000-0500		5	5	23	34	86	6
MG212C1000-0600		6	5.6	26	36	93	6
MG212C1000-0700		7	7.1	31	40	109	6
MG212C1000-0800		8	8	33	42	117	6
MG212C1000-0900	212-C	9	9	36	44	125	6
MG212C1000-1000		10	10	38	46	133	6
MG212C1000-1200		12	10	44	46	151	8
MG212C1000-1300		13	10	44	46	151	8
MG212C1000-1400		14	12.5	47	50	160	8
MG212C1000-1600		16	12.5	52	52	170	8
MG212C1000-2000		20	16	60	58	195	10

Expert Line

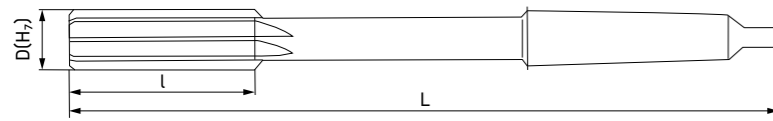

KOD PRODUKTU	D	l	L	nr stożka	Z
MG208A1000-0600	6	26	138	1	6
MG208A1000-0700	7	31	150	1	6
MG208A1000-0800	8	33	156	1	6
MG208A1000-0900	9	36	162	1	6
MG208A1000-1000	10	38	168	1	6
MG208A1000-1100	11	41	175	1	8
MG208A1000-1200	12	44	182	1	8
MG208A1000-1300	13	44	182	1	8
MG208A1000-1400	14	47	189	1	8
MG208A1000-1500	15	50	204	2	8
MG208A1000-1600	16	52	210	2	8
MG208A1000-1700	17	54	214	2	8
MG208A1000-1800	18	56	219	2	8
MG208A1000-1900	19	58	223	2	10
MG208A1000-2000	20	60	228	2	10
MG208A1000-2100	21	62	232	2	10
MG208A1000-2200	22	64	237	2	10
MG208A1000-2300	23	66	241	2	10
MG208A1000-2400	24	68	268	3	10
MG208A1000-2500	25	68	268	3	10
MG208A1000-2600	26	70	273	3	10
MG208A1000-3000	30	73	281	3	10
MG208A1000-3500	35	78	321	4	12

Expert Line

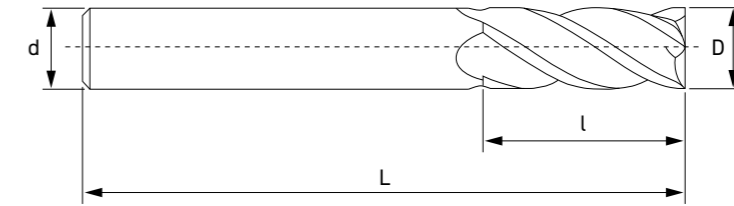

KOD PRODUKTU			D	d	l	L
4-ostrowe	3-ostrowe	2-ostrowe	(mm)	(mm)	(mm)	(mm)
MG454000Z4-0010		MG454000Z2-0010	1	4	3	50
MG454000Z4-0015		MG454000Z2-0015	1,5	4	4	50
MG454000Z4-0020	MG454000Z3-0020	MG454000Z2-0020	2	4	5	50
MG454000Z4-0025		MG454000Z2-0025	2,5	4	8	50
MG454000Z4-0030	MG454000Z3-0030	MG454000Z2-0030	3	3	8	50
MG454000Z4-L030			3	3	12	75
MG454000Z4-X030			3	3	15	100
MG454000Z4-0035		MG454000Z2-0035	3,5	4	10	50
MG454000Z4-0040	MG454000Z3-0040	MG454000Z2-0040	4	4	10	50
MG454000Z4-L040			4	4	16	75
MG454000Z4-X040			4	4	20	100
MG454000Z4-0050	MG454000Z3-0050	MG454000Z2-0050	5	5	13	50
MG454000Z4-L050			5	5	20	75
MG454000Z4-X050			5	5	25	100
MG454000Z4-0060	MG454000Z3-0060	MG454000Z2-0060	6	6	15	50
MG454000Z4-L060			6	6	25	75
MG454000Z4-X060			6	6	30	100
MG454000Z4-XL60			6	6	40	150
MG454000Z4-0070		MG454000Z2-0070	7	8	18	60
MG454000Z4-0080	MG454000Z3-0080	MG454000Z2-0080	8	8	20	60
MG454000Z4-L080			8	8	28	75
MG454000Z4-X080			8	8	35	100
MG454000Z4-XL80			8	8	50	150
MG454000Z4-0090		MG454000Z2-0090	9	10	23	75
MG454000Z4-0100	MG454000Z3-0100	MG454000Z2-0100	10	10	25	75
MG454000Z4-L100			10	10	40	100
MG454000Z4-X100			10	10	50	150
MG454000Z4-0110		MG454000Z2-0110	11	12	28	75
MG454000Z4-0120	MG454000Z3-0120	MG454000Z2-0120	12	12	30	75
MG454000Z4-L120			12	12	45	100
MG454000Z4-X120			12	12	60	150
MG454000Z4-0140	MG454000Z3-0140	MG454000Z2-0140	14	14	45	100
MG454000Z4-L140			14	14	60	150
MG454000Z4-0160	MG454000Z3-0160	MG454000Z2-0160	16	16	45	100
MG454000Z4-L160			16	16	60	150
MG454000Z4-0180	MG454000Z3-0180	MG454000Z2-0180	18	18	45	100
MG454000Z4-L180			18	18	70	150
MG454000Z4-0200	MG454000Z3-0200	MG454000Z2-0200	20	20	45	100
MG454000Z4-L200			20	20	70	150

inne rozmiary dostępne na zapytanie

SERIA 45

Frezy trzpieniowe pełnowęglkowe do obróbki stali i żeliwa o twardości do 45 HRC

## SERIA 55

Frezy trzpieniowe pełnowęglikowe do obróbki stali, stali nierdzewnej oraz żeliwa o twardości do 55 HRC

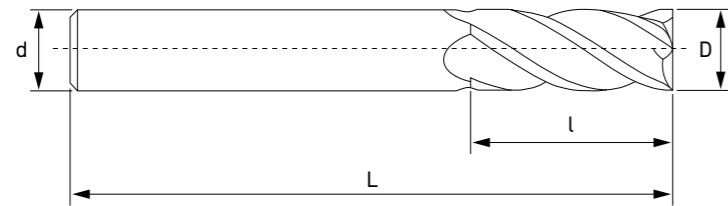

KOD PRODUKTU		D (mm)	d (mm)	l (mm)	L (mm)
<b>2-ostrzowe</b>	<b>4-ostrzowe</b>				
	<b>4-ostrzowe ZGRUBNE</b>				
MG554000Z2-0010	MG554000Z4-0010	1	4	3	50
MG554000Z2-0015	MG554000Z4-0015	1,5	4	4	50
MG554000Z2-0020	MG554000Z4-0020	2	4	5	50
MG554000Z2-0025	MG554000Z4-0025	2,5	4	8	50
MG554000Z2-0030	MG554000Z4-0030	3	3	8	50
MG554000Z2-0040	MG554000Z4-0040	4	4	10	50
MG554000Z2-0050	MG554000Z4-0050	5	5	13	50
MG554000Z2-0060	MG554000Z4-0060	6	6	15	50
MG554000Z2-0080	MG554000Z4-0080	8	8	20	60
MG554000Z2-0100	MG554000Z4-0100	10	10	25	75
MG554000Z2-0120	MG554000Z4-0120	12	12	30	75
MG554000Z2-0140	MG554000Z4-0140	14	14	45	100
MG554000Z2-0160	MG554000Z4-0160	16	16	45	100
MG554000Z2-0180	MG554000Z4-0180	18	18	45	100
MG554000Z2-0200	MG554000Z4-0200	20	20	45	100

inne rozmiary dostępne na zapytanie

## SERIA 55 R

Frezy trzpieniowe pełnowęglikowe do obróbki stali, stali nierdzewnej oraz żeliwa o twardości do 55 HRC

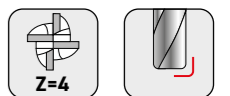
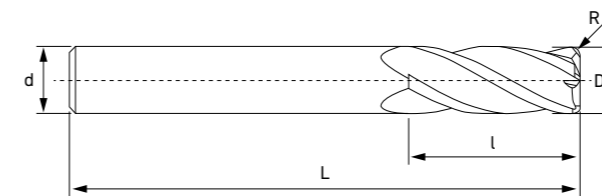
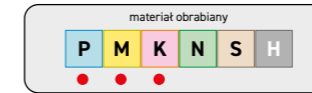

### SERIA 55 HRC 4-ostrzowe z promieniem naroża

KOD PRODUKTU	D (mm)	R (mm)	d (mm)	l (mm)	L (mm)
MG554R05Z4-0030	3	R0.5	4	8	50
MG554R10Z4-0030	3	R1	4	8	50
MG554R05Z4-0040	4	R0.5	4	10	50
MG554R10Z4-0040	4	R1	4	10	50
MG554R05Z4-0050	5	R0.5	5	13	50
MG554R10Z4-0050	5	R1.0	5	13	50
MG554R05Z4-0060	6	R0.5	6	15	50

KOD PRODUKTU	D (mm)	R (mm)	d (mm)	l (mm)	L (mm)
MG554R10Z4-0060	6	R1	6	15	50
MG554R05Z4-0080	8	R0.5	8	20	60
MG554R10Z4-0080	8	R1	8	20	60
MG554R05Z4-0100	10	R0.5	10	25	75
MG554R10Z4-0100	10	R1	10	25	75
MG554R05Z4-0120	12	R0.5	12	30	75
MG554R10Z4-0120	12	R1	12	30	75

inne rozmiary dostępne na zapytanie

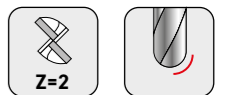
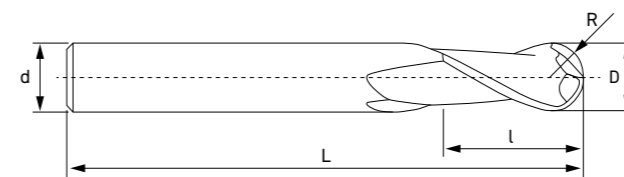

### SERIA 55 HRC 2-ostrzowe czoto kuliste

KOD PRODUKTU	D (mm)	R (mm)	d (mm)	l (mm)	L (mm)
MG5540BAZ2-0020	2	R1.0	4	4	50
MG5540BAZ2-0030	3	R1.5	3	6	50
MG5540BAZ2-0040	4	R2.0	4	8	50
MG5540BAZ2-0050	5	R2.5	5	10	50
MG5540BAZ2-0060	6	R3.0	6	12	50

KOD PRODUKTU	D (mm)	R (mm)	d (mm)	l (mm)	L (mm)
MG5540BAZ2-0080	8	R4.0	8	16	60
MG5540BAZ2-0100	10	R5.0	10	20	75
MG5540BAZ2-0120	12	R6.0	12	24	75
MG5540BAZ2-0140	14	R7.0	14	28	100
MG5540BAZ2-0160	16	R8.0	16	32	100

inne rozmiary dostępne na zapytanie



SERIA 60 INOX

Frezy ze zmienną geometrią ostrza 35°/38° do obróbki stali nierdzewnej do twardości do 60 HRC

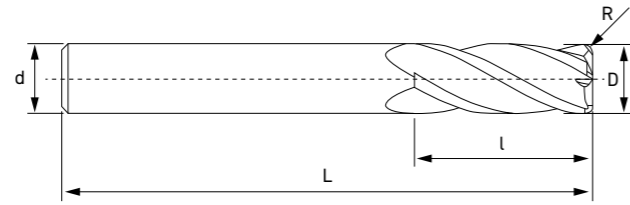

SERIA 60 HRC 4-ostrzowe INOX 35/38 ze zmienną spiralą i z promieniem naroża

KOD PRODUKTU	D (mm)	R (mm)	d (mm)	l (mm)	L (mm)
MG604R05Z4-0040	4	R0.5	10	4	50
MG604R05Z4-0050	5	R0.5	12	6	50
MG604R05Z4-0060	6	R0.5	15	6	50
MG604R05Z4-0080	8	R0.5	20	8	60
MG604R05Z4-0100	10	R0.5	25	10	75
MG604R05Z4-0120	12	R0.5	30	12	75
MG604R10Z4-0160	16	R1.0	40	16	100

inne rozmiary dostępne na zapytanie

SERIA 65

Frezy do obróbki materiałów trudnoobrabialnych do twardości do 65 HRC

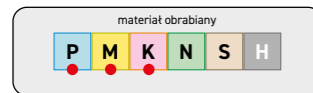
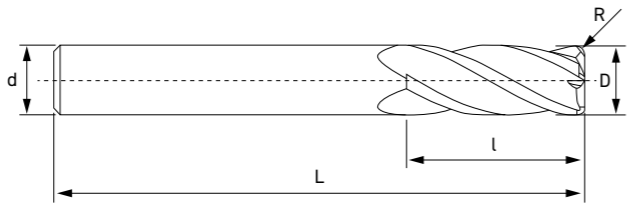

SERIA 65 HRC 4-ostrzowe

KOD PRODUKTU	D (mm)	d (mm)	l (mm)	L (mm)
MG654000Z4-0030	3	3	8	50
MG654000Z4-0040	4	4	10	50
MG654000Z4-0050	5	5	13	50
MG654000Z4-0060	6	6	15	50
MG654000Z4-0080	8	8	20	60
MG654000Z4-0100	10	10	25	75
MG654000Z4-0120	12	12	30	75
MG654000Z4-L040	4	4	16	75
MG654000Z4-L050	5	5	20	75
MG654000Z4-L060	6	6	25	75
MG654000Z4-L080	8	8	28	75
MG654000Z4-L100	10	10	40	100
MG654000Z4-L120	12	12	45	100

inne rozmiary dostępne na zapytanie

SERIA 65 HRC 4-ostrzowe z promieniem naroża

KOD PRODUKTU	D (mm)	R (mm)	d (mm)	l (mm)	L (mm)
MG654R05Z4-0030	3	R0.5	3	8	50
MG654R05Z4-0040	4	R0.5	4	10	50
MG654R05Z4-0050	5	R0.5	5	13	50
MG654R05Z4-0060	6	R0.5	6	15	50
MG654R05Z4-0080	8	R0.5	8	20	60
MG654R05Z4-0100	10	R0.5	10	25	75
MG654R05Z4-0120	12	R0.5	12	30	75
MG654R05Z4-L040	4	R0.5	4	16	75
MG654R05Z4-L050	5	R0.5	5	20	75
MG654R05Z4-L060	6	R0.5	6	25	75
MG654R05Z4-L080	8	R0.5	8	28	75
MG654R05Z4-L100	10	R0.5	10	40	100
MG654R05Z4-L120	12	R0.5	12	45	100

inne rozmiary dostępne na zapytanie

SERIA ALU

Frezy trzpieniowe pełnowęglikowe do obróbki aluminium

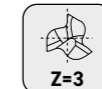
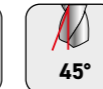
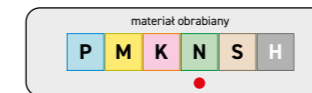
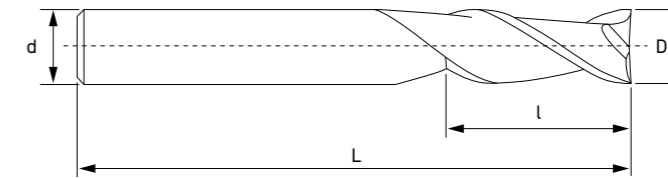

KOD PRODUKTU		D (mm)	d (mm)	l (mm)	L (mm)
ALU	ALU DLC				
MG5540ALZ3-0020	MG554ALDZ3-0020	2	4	6	50
MG5540ALZ3-0030	MG554ALDZ3-0030	3	3	9	50
MG5540ALZ3-L030		3	3	12	75
MG5540ALZ3-0040	MG554ALDZ3-0040	4	4	12	50
MG5540ALZ3-L040		4	4	16	75
MG5540ALZ3-0050	MG554ALDZ3-0050	5	5	15	50
MG5540ALZ3-L050		5	5	20	75
MG5540ALZ3-0060	MG554ALDZ3-0060	6	6	18	50
MG5540ALZ3-L060		6	6	30	75
MG5540ALZ3-0080	MG554ALDZ3-0080	8	8	24	60
MG5540ALZ3-L080		8	8	35	75
MG5540ALZ3-0100	MG554ALDZ3-0100	10	10	30	75
MG5540ALZ3-L100		10	10	40	100
MG5540ALZ3-0120	MG554ALDZ3-0120	12	12	36	75
MG5540ALZ3-L120		12	12	45	100
MG5540ALZ3-0140	MG554ALDZ3-0140	14	14	45	100
MG5540ALZ3-L140		14	14	65	150
MG5540ALZ3-0160	MG554ALDZ3-0160	16	16	45	100
MG5540ALZ3-L160		16	16	65	150
MG5540ALZ3-0180		18	18	45	100
MG5540ALZ3-L180		18	18	70	150
MG5540ALZ3-0200		20	20	45	100
MG5540ALZ3-L200		20	20	70	150

inne rozmiary dostępne na zapytanie

## SERIA EXPERT LINE

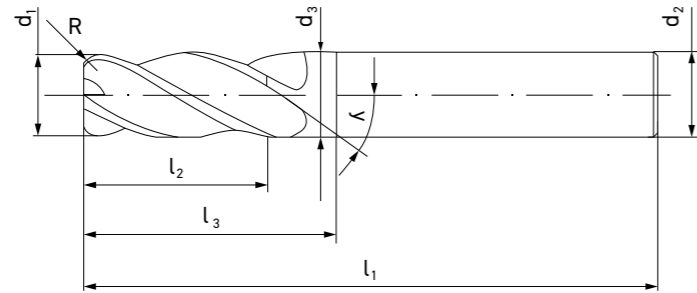

KOD PRODUKTU	Ød1	Ød2h6	d3	l1	l2	l3	Z	R
MG04504800-0060	6	6	5,5	57	13	21	4	-
MG04504800-0080	8	8	7,5	63	19	27	4	-
MG04504800-0100	10	10	9,5	72	22	32	4	-
MG04504800-0120	12	12	11,5	83	26	38	4	-
MG04504800-0140	14	14	13	83	26	38	4	-
MG04504800-0160	16	16	15	92	32	44	4	-
MG04504800-0180	18	18	17	92	32	44	4	-
MG04504800-0200	20	20	19	104	38	55	4	-

Expert Line

### z promieniem naroża



KOD PRODUKTU	Ød1	Ød2h6	d3	l1	l2	l3	Z	R
MGR45048RA-0060	6	6	5,5	57	13	21	4	0,25
MGR45048RB-0060	6	6	5,5	57	13	21	4	0,5
MGR45048RA-0080	8	8	7,5	63	19	27	4	0,5
MGR45048RA-0100	10	10	9,5	72	22	32	4	0,5
MGR45048RA-0120	12	12	11,5	83	26	38	4	0,5
MGR45048RA-0140	14	14	13	83	26	38	4	0,5
MGR45048RA-0160	16	16	15	92	32	44	4	0,5
MGR45048RC-0160	16	16	15	92	32	44	4	1
MGR45048RA-0180	18	18	17	92	32	44	4	0,5
MGR45048RA-0200	20	20	19	104	38	55	4	0,5
MGR45048RC-0200	20	20	19	104	38	55	4	1

Expert Line

### z czółem kulistym



KOD PRODUKTU	Ød1	Ød2h6	d3	l1	l2	l3	Z	R
MGB4504800-0030	3	6	-	57	8	-	4	1,5
MGB4504800-0040	4	6	-	57	11	-	4	2,0
MGB4504800-0050	5	6	-	57	13	-	4	2,5
MGB4504800-0060	6	6	5,5	57	13	21	4	3,0
MGB4504800-0080	8	8	7,5	63	19	27	4	4,0
MGB4504800-0100	10	10	9,5	72	22	32	4	5,0
MGB4504800-0120	12	12	11,5	83	26	38	4	6,0
MGB4504800-0140	14	14	13	83	26	38	4	7,0
MGB4504800-0160	16	16	15	92	32	44	4	8,0
MGB4504800-0180	18	18	17	92	32	44	4	9,0
MGB4504800-0200	20	20	19	104	38	55	4	10,0

Expert Line

## SERIA 45

Materiał obrabiany	Wytrzymałość (N/mm <sup>2</sup> )	Prędkość skrawania V <sub>c</sub> (m/mm)	Posuw f <sub>z</sub> (mm/ostre)					
			Średnica (mm)					
			<4	4-7	7-11	11-16	16-20	
Stal konstrukcyjna	< 500	●	70-120	0,03	0,04	0,05	0,07	0,08
		●●	100-160	0,02	0,03	0,04	0,06	0,07
Stal automatowa	< 700	●	70-100	0,03	0,04	0,05	0,06	0,07
		●●	90-140	0,01	0,02	0,03	0,05	0,06
Stal do ulepszenia cieplnego	< 1000	●	60-100	0,02	0,03	0,04	0,06	0,07
		●●	90-120	0,01	0,02	0,03	0,04	0,05
Żeliwo szare	< 200 HB	●	60-100	0,03	0,05	0,07	0,09	0,11
		●●	80-130	0,02	0,03	0,04	0,06	0,08
Żeliwo sferoidalne	< 260 HB	●	60-100	0,02	0,04	0,04	0,05	0,06
		●●	80-130	0,01	0,03	0,03	0,04	0,05

● Obróbka zgrubna  
●● Obróbka wykańczająca

## SERIA 55

Materiał obrabiany	Wytrzymałość (N/mm <sup>2</sup> )	Prędkość skrawania V <sub>c</sub> (m/mm)	Posuw f <sub>z</sub> (mm/ostre)					
			Średnica (mm)					
			<4	4-7	7-11	11-16	16-20	
Stal konstrukcyjna	< 500	●	70-120	0,03	0,04	0,05	0,07	0,08
		●●	100-160	0,02	0,03	0,04	0,06	0,07
Stal automatowa	< 700	●	70-100	0,03	0,04	0,05	0,06	0,07
		●●	90-140	0,01	0,02	0,03	0,05	0,06
Stal do ulepszenia cieplnego	< 1000	●	60-100	0,02	0,03	0,04	0,06	0,07
		●●	90-120	0,01	0,02	0,03	0,04	0,05
Stal narzędziowa	< 1400	●	60-100	0,01	0,03	0,04	0,05	0,06
		●●	80-120	0,01	0,02	0,03	0,04	0,05
Stal narzędziowa	>1400	●	50-70	0,01	0,03	0,04	0,05	0,06
		●●	60-90	0,01	0,02	0,03	0,04	0,05
Stal nierdzewna	< 850	●	50-70	0,02	0,03	0,04	0,05	0,06
		●●	60-110	0,02	0,02	0,03	0,03	0,04
		●●	60-110	0,02	0,02	0,03	0,04	0,05
850-1200	●	50-70	0,02	0,03	0,04	0,05	0,06	
	●●	60-110	0,02	0,02	0,03	0,04	0,05	
Żeliwo szare	< 200 HB	●	70-100	0,03	0,05	0,07	0,09	0,11
		●●	80-120	0,02	0,03	0,04	0,06	0,08
Żeliwo sferoidalne	< 260 HB	●	70-100	0,02	0,04	0,04	0,05	0,06
		●●	80-120	0,01	0,03	0,03	0,04	0,05

● Obróbka zgrubna  
●● Obróbka wykańczająca

## SERIA 60 INOX

Materiał obrabiany	Wytrzymałość (N/mm <sup>2</sup> )	Prędkość skrawania V <sub>c</sub> (m/mm)	Posuw f <sub>z</sub> (mm/ostre)					
			Średnica (mm)					
			<4	4-7	7-11	11-16	16-20	
Stal konstrukcyjna	< 500	●	180-200	0,03	0,04	0,05	0,07	0,08
		●●	190-230	0,02	0,03	0,04	0,06	0,07
Stal automatowa	< 700	●	150-180	0,03	0,04	0,05	0,06	0,07
		●●	170-220	0,01	0,02	0,03	0,05	0,06
Stal do ulepszenia cieplnego	< 1000	●	130-160	0,02	0,03	0,04	0,06	0,07
		●●	150-200	0,01	0,02	0,03	0,04	0,05
Stal narzędziowa	< 1400	●	100-130	0,01	0,03	0,04	0,05	0,06
		●●	120-150	0,01	0,02	0,03	0,04	0,05
Stal narzędziowa	>1400	●	90-110	0,01	0,03	0,04	0,05	0,06
		●●	110-140	0,01	0,02	0,03	0,04	0,05
Stal nierdzewna	< 850	●	130-150	0,02	0,03	0,04	0,05	0,06
		●●	150-180	0,02	0,02	0,03	0,03	0,04
		●●	80-100	0,02	0,03	0,04	0,05	0,06
850-1200	●	90-120	0,02	0,02	0,03	0,04	0,05	
	●●	90-120	0,02	0,02	0,03	0,04	0,05	
Żeliwo szare	< 200 HB	●	150-180	0,03	0,05	0,07	0,09	0,11
		●●	160-200	0,02	0,03	0,04	0,06	0,08
Żeliwo sferoidalne	< 260 HB	●	130-160	0,02	0,04	0,04	0,05	0,06
		●●	160-200	0,01	0,03	0,03	0,04	0,05

● Obróbka zgrubna  
●● Obróbka wykańczająca



## SERIA 800 OX

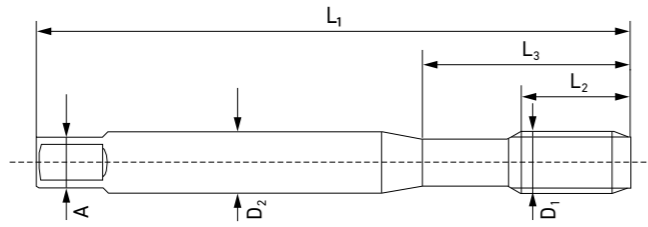

KOD PRODUKTU	nazwa	MØD1	P	L1	L2	L3	ØD2	A	
7602021CE030050	DIN 371-B M3 6H HSSE 800	M 3	0,5	56	10	18	3,5	2,7	2,50
7602021CE040070	DIN 371-B M4 6H HSSE 800	M 4	0,7	63	12	19	4,5	3,4	3,30
7602021CE050080	DIN 371-B M5 6H HSSE 800	M 5	0,8	70	12	24	6	4,9	4,20
7602021CE060100	DIN 371-B M6 6H HSSE 800	M 6	1	80	15	30	6	4,9	5,00
7602021CE080125	DIN 371-B M8 6H HSSE 800	M 8	1,25	90	18	34	8	6,2	6,75
7602021CE100150	DIN 371-B M10 6H HSSE 800	M 10	1,5	100	21	40	10	8	8,50
7603021CE120175	DIN 376-B M12 6H HSSE 800	M 12	1,75	110	22	-	9	7	10,20
7603021CE140200	DIN 376-B M14 6H HSSE 800	M 14	2	110	25	-	11	9	12,00
7603021CE160200	DIN 376-B M16 6H HSSE 800	M 16	2	110	28	-	12	9	14,00
7603021CE180250	DIN 376-B M18 6H HSSE 800	M 18	2,5	125	32	-	14	11	15,50
7602051CE030050	DIN 371-C M3 6H R40 HSSE 800	M 3	0,5	56	5	18	3,5	2,7	2,50
7602051CE040070	DIN 371-C M4 6H R40 HSSE 800	M 4	0,7	63	7	19	4,5	3,4	3,30
7602051CE050080	DIN 371-C M5 6H R40 HSSE 800	M 5	0,8	70	8	24	6	4,9	4,20
7602051CE060100	DIN 371-C M6 6H R40 HSSE 800	M 6	1	80	10	30	6	4,9	5,00
7602051CE080125	DIN 371-C M8 6H R40 HSSE 800	M 8	1,25	90	14	36	8	6,2	6,80
7602051CE100150	DIN 371-C M10 6H R40 HSSE 800	M 10	1,5	100	16	40	10	8	8,50
7603051CE120175	DIN 376-C M12 6H R40 HSSE 800	M 12	1,75	110	16	-	9	7	10,20
7603051CE140200	DIN 376-C M14 6H R40 HSSE 800	M 14	2	110	18	-	11	9	12,00
7603051CE160200	DIN 376-C M16 6H R40 HSSE 800	M 16	2	110	18	-	12	9	14,00

Zalecane parametry skrawania – s. 28

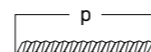

## SERIA 800 TN

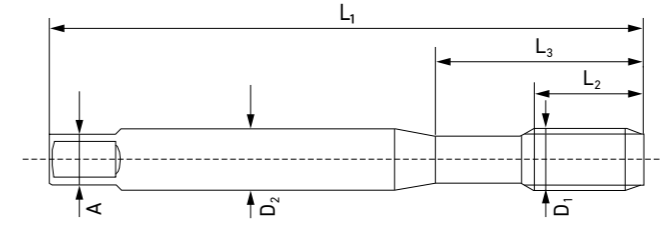

KOD PRODUKTU	nazwa	MØD1	P	L1	L2	L3	ØD2	A	
MG371B1400-0030	800 M3-6H DIN-371 B HSSE TN	M3	0,50	56	10	18	3,5	2,7	2,50
MG371B1400-0040	800 M4-6H DIN-371 B HSSE TN	M4	0,70	63	12	21	4,5	3,4	3,30
MG371B1400-0050	800 M5-6H DIN-371 B HSSE TN	M5	0,80	70	14	25	6,0	4,9	4,20
MG371B1400-0060	800 M6-6H DIN-371 B HSSE TN	M6	1,00	80	18	30	6,0	4,9	5,00
MG371B1400-0080	800 M8-6H DIN-371 B HSSE TN	M8	1,25	90	20	35	8,0	6,2	6,80
MG371B1400-0083	800 M8x1-6H DIN-371 B HSSE TN	M8x1	1,00	90	20	35	8,0	6,2	7,00
MG371B1400-0100	800 M10-6H DIN-371 B HSSE TN	M10	1,50	100	20	39	10,0	8,0	8,50
MG371B1400-0103	800 M10x1-6H DIN-371 B HSSE TN	M10x1	1,00	90	20	35	10,0	8,0	9,00
MG371B1400-0104	800 M10x1,25-6H DIN-371 B HSSE TN	M10x1,25	1,25	100	20	39	10,0	8,0	8,80
MG376B1400-0120	800 M12-6H DIN-376 B HSSE TN	M 12	1,75	110	24	-	9,0	7,0	10,20
MG374B1400-0125	800 M12x1,5-6H DIN-374 B HSSE TN	M12x1,5	1,50	100	20	-	9,0	7,0	10,50
MG376B1400-0140	800 M14-6H DIN-376 B HSSE TN	M14	2,00	110	25	-	11,0	9,0	12,00
MG376B1400-0160	800 M16-6H DIN-376 B HSSE TN	M16	2,00	110	32	-	12,0	9,0	14,00
MG374B1400-0165	800 M16x1,5-6H DIN-374 B HSSE TN	M16x1,5	1,50	100	20	-	12,0	9,0	14,50
MG376B1400-0180	800 M18-6H DIN-376 B HSSE TN	M18	2,50	125	32	-	14,0	11,0	15,50
MG376B1400-0200	800 M20-6H DIN-376 B HSSE TN	M20	2,50	140	32	-	16,0	12,0	17,50
MG376B1400-0220	800 M22-6H DIN-376 B HSSE TN	M22	2,50	140	32	-	18,0	14,5	19,50
MG376B1400-0240	800 M24-6H DIN-376 B HSSE TN	M24	3,00	160	38	-	18,0	14,5	21,00
MG376B1400-0300	800 M30-6H DIN-376 B HSSE TN	M30	3,50	180	45	-	22,0	18,0	26,50
MG371C14R0-0030	800 M3-6H DIN-371 C R40 HSSE TN	M3	0,50	56	5	18	3,5	2,7	2,50
MG371C14R0-0040	800 M4-6H DIN-371 C R40 HSSE TN	M4	0,70	63	7	21	4,5	3,4	3,30
MG371C14R0-0050	800 M5-6H DIN-371 C R40 HSSE TN	M5	0,80	70	8	25	6,0	4,9	4,20
MG371C14R0-0060	800 M6-6H DIN-371 C R40 HSSE TN	M6	1,00	80	10	30	6,0	4,9	5,00
MG371C14R0-0080	800 M8-6H DIN-371 C R40 HSSE TN	M8	1,25	90	13	35	8,0	6,2	6,80
MG371C14R0-0083	800 M8x1-6H DIN-371 C R40 HSSE TN	M8x1	1,00	90	13	35	8,0	6,2	7,00
MG371C14R0-0100	800 M10-6H DIN-371 C R40 HSSE TN	M10	1,50	100	15	39	10,0	8,0	8,50
MG371C14R0-0103	800 M10x1-6H DIN-371 C R40 HSSE TN	M10x1	1,00	90	13	35	10,0	8,0	9,00
MG371C14R0-0104	800 M10x1,25-6H DIN-371 C R40 HSSE TN	M10x1,25	1,25	100	15	39	10,0	8,0	8,80
MG376C14R0-0120	800 M12-6H DIN-376 C R40 HSSE TN	M12	1,75	110	18	-	9,0	7,0	10,20
MG374C14R0-0125	800 M12x1,5-6H DIN-374 C R40 HSSE TN	M12x1,5	1,50	100	15	-	9,0	7,0	10,50
MG376C14R0-0140	800 M14-6H DIN-376 C R40 HSSE TN	M14	2,00	110	20	-	11,0	9,0	12,00
MG374C14R0-0145	800 M14x1,5-6H DIN-374 C R40 HSSE TN	M14x1,5	1,50	100	15	-	11,0	9,0	12,50
MG376C14R0-0160	800 M16-6H DIN-376 C R40 HSSE TN	M16	2,00	110	20	-	12,0	9,0	14,00
MG374C14R0-0165	800 M16x1,5-6HX DIN-374 C R40 HSSE TN	M16x1,5	1,50	100	15	-	12,0	9,0	14,50
MG376C14R0-0200	800 M20-6HX DIN-376 C R40 HSSE TN	M20	2,50	140	25	-	16,0	12,0	17,50
MG376C14R0-0240	800 M24-6H DIN-376 C R40 HSSE TN	M24	3,00	160	30	-	18,0	14,5	21,00
MG376C14R0-0300	800 M30-6H DIN-376 C R40 HSSE TN	M30	3,50	180	35	-	22,0	18,0	26,50

Zalecane parametry skrawania – s. 28

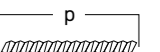



SERIA 1000 TiN

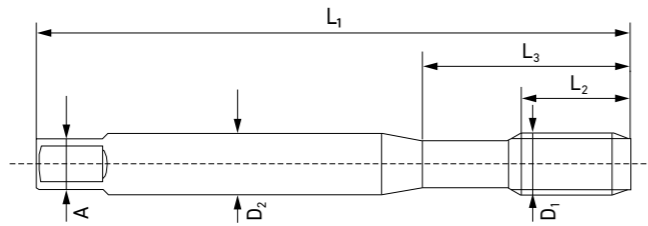

HSSE
DIN 371
DIN 376
TiN
materiał obrabiany: P M K N S H



KOD PRODUKTU	nazwa	MØD1	P	L1	L2	L3	ØD2	A	
7602921CE030050	DIN 371-B M3 6H HSSE TiN/1000	M 3	0,5	56	10	18	3,5	2,7	2,50
7602921CE040070	DIN 371-B M4 6H HSSE TiN/1000	M 4	0,7	63	12	19	4,5	3,4	3,30
7602921CE050080	DIN 371-B M5 6H HSSE TiN/1000	M 5	0,8	70	12	24	6	4,9	4,20
7602921CE060100	DIN 371-B M6 6H HSSE TiN/1000	M 6	1	80	15	30	6	4,9	5,00
7602921CE080125	DIN 371-B M8 6H HSSE TiN/1000	M 8	1,25	90	18	34	8	6,2	6,80
7602921CE100150	DIN 371-B M10 6H HSSE TiN/1000	M 10	1,5	100	21	40	10	8	8,50
7603921CE120175	DIN 376-B M12 6H HSSE TiN/1000	M 12	1,75	110	22	-	9	7	10,20
7603921CE140200	DIN 376-B M14 6H HSSE TiN/1000	M 14	2	110	25	-	11	9	12,00
7603921CE160200	DIN 376-B M16 6H HSSE TiN/1000	M 16	2	110	28	-	12	9	14,00
7603921CE180250	DIN 376-B M18 6H HSSE TiN/1000	M 18	2,5	125	32	-	14	11	15,50
7603921CE200250	DIN 376-B M20 6H HSSE TiN/1000	M 20	2,5	140	32	-	16	12	17,50
7603921CE240300	DIN 376-B M24 6H HSSE TiN/1000	M 24	3	160	32	-	18	14,5	21,00
7602951CE030050	DIN 371-C M3 6H R40 HSSE TiN/1000	M 3	0,5	56	5	18	3,5	2,7	2,50
7602951CE040070	DIN 371-C M4 6H R40 HSSE TiN/1000	M 4	0,7	63	7	19	4,5	3,4	3,30
7602951CE050080	DIN 371-C M5 6H R40 HSSE TiN/1000	M 5	0,8	70	8	24	6	4,9	4,20
7602951CE060100	DIN 371-C M6 6H R40 HSSE TiN/1000	M 6	1	80	10	30	6	4,9	5,00
7602951CE080125	DIN 371-C M8 6H R40 HSSE TiN/1000	M 8	1,25	90	14	36	8	6,2	6,80
7602951CE100150	DIN 371-C M10 6H R40 HSSE TiN/1000	M 10	1,5	100	16	40	10	8	8,50
7603951CE120175	DIN 376-C M12 6H R40 HSSE TiN/1000	M 12	1,75	110	16	-	9	7	10,20
7603951CE140200	DIN 376-C M14 6H R40 HSSE TiN/1000	M 14	2	110	18	-	11	7	12,00
7603951CE160200	DIN 376-C M16 6H R40 HSSE TiN/1000	M 16	2	110	18	-	12	9	14,00
7603951CE180250	DIN 376-C M18 6H R40 HSSE TiN/1000	M 18	2,5	125	25	-	14	11	15,50

Zalecane parametry skrawania – s. 28

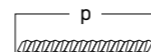

SERIA EXPERT

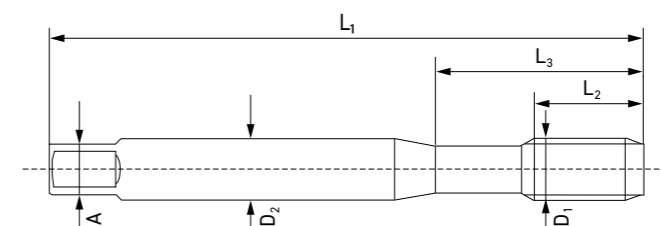

HSSE PM
DIN 371
DIN 376
HL
materiał obrabiany: P M K N S H



KOD PRODUKTU	nazwa	MØD1	P	L1	L2	L3	ØD2	A	
MG371B3300-0020	M2-6H DIN-371 B HSSE-PM HL	M2	0,40	45	10	13	2,8	2,1	1,60
MG371B3300-0030	M3-6HX DIN-371 B HSSE-PM HL	M3	0,50	56	5	18	3,5	2,7	2,50
MG371B3300-0040	M4-6HX DIN-371 B HSSE-PM HL	M4	0,70	63	7	21	4,5	3,4	3,30
MG371B3300-0050	M5-6HX DIN-371 B HSSE-PM HL	M5	0,80	70	8	25	6,0	4,9	4,20
MG371B3300-0060	M6-6HX DIN-371 B HSSE-PM HL	M6	1,00	80	10	30	6,0	4,9	5,00
MG371B3300-0070	M7-6HX DIN-371 B HSSE-PM HL	M7	1,00	80	10	30	7,0	5,5	6,00
MG371B3300-0080	M8-6HX DIN-371 B HSSE-PM HL	M8	1,25	90	13	35	8,0	6,2	6,80
MG371B3300-0100	M10-6HX DIN-371 B HSSE-PM HL	M10	1,50	100	15	39	10,0	8,0	8,50
MG376B3300-0120	M12-6HX DIN-376 B HSSE-PM HL	M12	1,75	110	18	-	9,0	7,0	10,20
MG376B3300-0140	M14-6HX DIN-376 B HSSE-PM HL	M14	2,00	110	20	-	11,0	9,0	12,00
MG376B3300-0160	M16-6HX DIN-376 B HSSE-PM HL	M16	2,00	110	20	-	12,0	9,0	14,00
MG376B3300-0180	M18-6HX DIN-376 B HSSE-PM HL	M18	2,50	125	25	-	14,0	11,0	15,50
MG376B3300-0200	M20-6HX DIN-376 B HSSE-PM HL	M20	2,50	140	25	-	16,0	12,0	17,50
MG376B3300-0220	M22-6HX DIN-376 B HSSE-PM HL	M22	2,50	140	25	-	18,0	14,5	19,50
MG376B3300-0240	M24-6HX DIN-376 B HSSE-PM HL	M24	3,00	160	30	-	18,0	14,5	21,00
MG371C33R0-0020	M2-6H DIN-371 C R45 HSSE-PM HL	M2	0,40	45	10	13	2,8	2,1	1,60
MG371C33R0-0030	M3-6HX DIN-371 C R45 HSSE-PM HL	M3	0,50	56	5	18	3,5	2,7	2,50
MG371C33R0-0040	M4-6HX DIN-371 C R45 HSSE-PM HL	M4	0,70	63	7	21	4,5	3,4	3,30
MG371C33R0-0050	M5-6HX DIN-371 C R45 HSSE-PM HL	M5	0,80	70	8	25	6,0	4,9	4,20
MG371C33R0-0060	M6-6HX DIN-371 C R45 HSSE-PM HL	M6	1,00	80	10	30	6,0	4,9	5,00
MG371C33R0-0080	M8-6HX DIN-371 C R45 HSSE-PM HL	M8	1,25	90	13	35	8,0	6,2	6,80
MG371C33R0-0100	M10-6HX DIN-371 C R45 HSSE-PM HL	M10	1,50	100	15	39	10,0	8,0	8,50
MG376C33R0-0120	M12-6HX DIN-376 C R45 HSSE-PM HL	M12	1,75	110	18	-	9,0	7,0	10,20
MG376C33R0-0140	M14-6HX DIN-376 C R45 HSSE-PM HL	M14	2,00	110	20	-	11,0	9,0	12,00
MG376C33R0-0160	M16-6HX DIN-376 C R45 HSSE-PM HL	M16	2,00	110	20	-	12,0	9,0	14,00
MG376C33R0-0180	M18-6HX DIN-376 C R45 HSSE-PM HL	M18	2,50	125	25	-	14,0	11,0	15,50
MG376C33R0-0200	M20-6HX DIN-376 C R45 HSSE-PM HL	M20	2,50	140	25	-	16,0	12,0	17,50
MG376C33R0-0220	M22-6HX DIN-376 C R45 HSSE-PM HL	M22	2,50	140	25	-	18,0	14,5	19,50
MG376C33R0-0240	M24-6HX DIN-376 C R45 HSSE-PM HL	M24	3,00	160	30	-	18,0	14,5	21,00

Zalecane parametry skrawania – s. 28

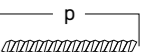

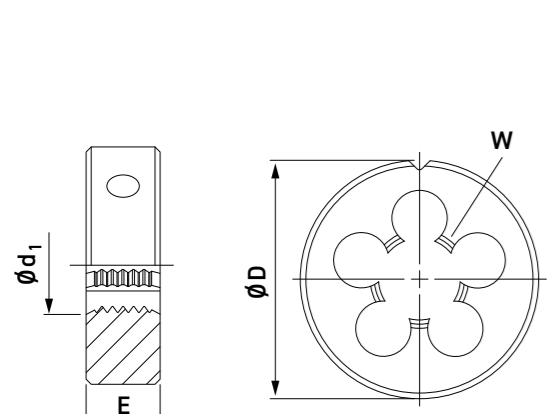

materiał obrabiany

P	M	K	N	S	H
---	---	---	---	---	---

HSS

materiał obrabiany

P	M	K	N	S	H
---	---	---	---	---	---

HSSE

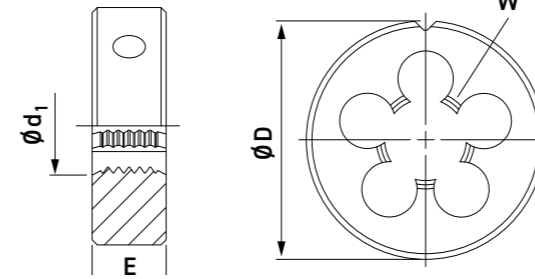

materiał obrabiany

P	M	K	N	S	H
---	---	---	---	---	---

HSS

materiał obrabiany

P	M	K	N	S	H
---	---	---	---	---	---

HSSE



G

DIN-EN 24231

55°

**RUROWE WALCOWE**

**METRYCZNE**

M

DIN-EN 22568

60°

KOD PRODUKTU

HSS INOX

G	MG24231000	MG2423110I	$\phi d_1$	1"/P	P	$\phi D \times E$	W	$\phi$ pręta
G1/8	-3123	-3123	9,73	28	0,907	30x11	4	9,62
G1/4	-3127	-3127	13,16	19	1,337	38x10	4	13,03
G3/8	-3129	-3129	16,66	19	1,337	45x14	5	16,54
G1/2	-3131	-3131	20,96	14	1,814	45x14	6	20,81
G5/8	-3133	-3133	20,91	14	1,814	55x16	5	22,77
G3/4	-3135	-3135	26,44	14	1,814	55x16	6	26,3
G7/8	-3137	-3137	30,20	14	1,814	65x18	6	30,06

Zalecane parametry skrawania – s. 29

UNC

DIN-EN 22568

60°

**AMERYKAŃSKIE UNC**

KOD PRODUKTU

HSS

UNC	MG22568000	$\phi d_1$	1"/P	P	$\phi D \times E$	W	$\phi$ pręta
1/4-20	-4127	6,35	20	1,270	20x7	4	6,22
5/16-18	-4128	7,94	18	1,411	25x9	4	7,80
3/8-16	-4129	9,53	16	1,588	30x11	4	9,37
7/16-14	-4130	11,11	14	1,814	30x11	4	10,95
1/2-13	-4131	12,7	13	1,954	38x14	4	12,52
9/16-12	-4132	14,29	12	2,117	38x14	4	14,10
5/8-11	-4133	15,88	11	2,309	45x18	5	15,68
3/4-10	-4135	19,05	10	2,504	45x18	5	18,84
7/8-9	-4137	22,23	9	2,822	55x22	5	22,00
1-8	-4139	25,4	8	3,175	55x22	5	25,16

Przykład kodu produktu: MG22568000-4127 – narzynka HSS 1/4-20 gwint amerykański UNC  
Zalecane parametry skrawania – s. 29

KOD PRODUKTU

HSS INOX

M $\phi d_1$	MG22568000	MG2256810I	P	$\phi D \times E$	W	$\phi$ pręta
M2	-0020	x	0,4	16x5	3	1,95
M2,5	-0025	x	0,45	16x5	3	2,42
M3	-0030	-0030	0,5	20x5	3	2,92
M4	-0040	-0040	0,7	20x5	3	3,9
M5	-0050	-0050	0,8	20x7	3	4,9
M6	-0060	-0060	1	20x7	4	5,88
M7	-0070	x	1	25x9	4	6,88
M8	-0080	-0080	1,25	25x9	4	7,86
M8x0,5	-0081	-0081	0,5	25x9	4	7,92
M8x0,75	-0082	-0082	0,75	25x9	4	7,9
M8x1	-0083	-0083	1	25x9	4	7,88
M9	-0090	x	1,25	25x9	4	8,86
M10	-0100	-0100	1,5	30x11	4	9,85
M10x0,75	-0102	-0102	0,75	30x11	4	9,9
M10x1	-0103	-0103	1	30x11	5	9,88
M10x1,25	-0104	-0104	1,25	30x11	4	9,86
M11	-0110	x	1,5	30x11	4	10,85
M12	-0120	-0120	1,75	38x14	4	11,83
M12x1	-0123	-0123	1	38x10	4	11,88
M12x1,25	-0124	-0124	1,25	38x10	4	11,86
M12x1,5	-0125	-0125	1,5	38x10	4	11,85
M14	-0140	-0140	2	38x14	4	13,82
M14x1	-0143	-0143	1	38x10	5	13,88

Przykład kodu produktu: MG22568000-0020 – narzynka HSS M2 gwint metryczny  
Zalecane parametry skrawania – s. 29

KOD PRODUKTU

HSS INOX

M $\phi d_1$	MG22568000	MG2256810I	P	$\phi D \times E$	W	$\phi$ pręta
M14x1,5	-0145	-0145	1,5	38x10	5	13,85
M16	-0160	-0160	2	45x18	5	15,82
M16x1	-0163	-0163	1	45x40	5	15,88
M16x1,5	-0165	-0165	1,5	45x14	5	15,85
M18	-0180	-0180	2,5	45x18	5	17,79
M18x1	-0183	-0183	1	45x14	5	17,88
M18x1,5	-0185	-0185	1,5	45x14	5	17,85
M18x2	-0186	-0186	2	45x14	5	17,82
M20	-0200	-0200	2,5	45x18	5	19,79
M20x1	-0203	-0203	1	45x14	6	19,8
M20x1,5	-0205	-0205	1,5	45x14	6	19,85
M20x2	-0206	-0206	2	45x14	6	19,82
M22	-0220	-0220	2,5	55x22	5	21,79
M22x1	-0223	-0223	1	55x16	6	21,88
M22x1,5	-0225	-0225	1,5	55x16	6	21,85
M22x2	-0226	-0226	2	55x16	6	21,82
M24	-0240	-0240	3	55x22	5	23,76
M24x1	-0243	x	1	55x16	6	23,88
M24x1,5	-0245	-0245	1,5	55x16	6	23,85
M24x2	x	-0246	2	55x16	6	23,82
M27	x	-0270	3	65x25	5	26,76
M30	-0300	-0300	3,5	65x25	6	29,73
M36	-0360	x	4	65x25	7	35,7

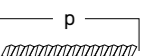
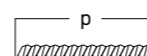

Expert Line	800 TN	800 OX	1000 TIN
NAKRÓJ			

GRUPA	MATERIAŁ OBRABIANY	Rm	HB	B	C R45	B	C R40	B	C R40	B	C R40
<b>Stal</b>											
<b>Vc (m/min)</b>											
P1	Stal automatowa	750	220	10-40	10-40	10-35	10-35	15-20	15-25	10-30	10-30
P2	C ≤ 0,55 %	650	190	10-40	10-40	10-35	10-35	15-20	15-25	10-30	10-30
P3	Stal węglowa C > 0,55 %	650	190	10-40	10-40	10-35	10-35	15-20	15-25	10-30	10-30
P4	C ≤ 0,55 %	700	210	10-40	10-40	10-35	10-35	15-20	15-25	10-30	10-30
P5	C > 0,55 %	1000	300	10-40	10-40	5-20	5-20			5-15	5-15
P6		600	175	10-40	10-40	10-35	10-35	15-20	15-25	10-30	10-30
P7	Stal niskostopowa	1000	300	10-40	10-40	5-20	5-20			5-15	5-15
P8		1200	380	10-40	10-40						
P9		1400	420	5-15 <sup>1)</sup>							
P10		700	210	10-40	10-40	10-35	10-35	15-20	15-25	10-30	10-30
P11	Stal wysokostopowa i wysokostopowa stal narzędziowa	1000	300	10-40	10-40						
P12		1400	420	5-15 <sup>1)</sup>							
P13	Stal nierdzewna Ferrytyczna / Martenzytyczna	700	210	5-15	5-15	5-15	5-15			5-10	5-10
P14	Martenzytyczna	1100	330	5-15	5-15	5-15	5-15			5-10	5-10
<b>Stal nierdzewna</b>											
M1	Stal nierdzewna Austenityczna	700	210	5-15	5-15	5-15	5-15	5-7	5-7	5-10	5-10
M2	Austenityczna (PH)	1000	300	5-15	5-15	5-15	5-15	5-7	5-7	5-10	5-10
M3	Duplex	800	240	5-15	5-15	5-15	5-15				
<b>Żeliwo</b>											
K1	Żeliwo szare (GJL)	400	120	10-30	10-30	5-15		5-15		5-10	
K2	Żeliwo wermikularne (GJV) CGI	550	160	10-30	10-30	5-15		5-15		5-10	
K3	Żeliwo ciągliwe (GJMW / GJMB)	500	150	10-30	10-30	10-25	10-25	5-15	5-15	10-20	10-20
K4	Żeliwo ciągliwe (GJMB)	800	240	10-30	10-30	10-25	10-25	5-15	5-15	10-20	10-20
K5	Żeliwo sferoidalne (GJS)	700	210	10-30	10-30	10-25	10-25	5-15	5-15	10-20	10-20
K6	Żeliwo sferoidalne (GJS) ADI	1400	420	5-15 <sup>1)</sup>	5-15 <sup>1)</sup>						
<b>Metale nieżelazne</b>											
N1	Stopy aluminium do obróbki plastycznej (ENAW)	200	-	10-30	10-30						
N2		500	152	10-30	10-30						
N3	Stopy aluminium Si ≤ 12%	250	75	10-30	10-30	10-30	10-20	10-20	10-20	10-25	10-20
N4	Stopy aluminium odlewnicze (ENAC) Si ≤ 12%	300	90	10-30	10-30	10-30	10-20	10-20	10-20	10-25	10-20
N5	(ENAC) Si > 12 %	450	130	10-30	10-30	10-30	10-20	10-20	10-20	10-25	10-20
N6	Stopy magnezu	250	70	10-30	10-30						
N7	Czysta miedź, niestopowa	350	100	10-30	10-30	10-30	10-30	5-15	5-15	10-25	10-20
N8	Stopy miedzi długowłórowe	600	180	10-30	10-30	10-30	10-30	5-15	5-15	10-25	10-20
N9	Miedź i jej stopy Stopy miedzi krótkowłórowe (mosiądz, brąz)	400	120	10-30	10-30						
N10	Wysoka wytrzymałość	1000	300	5-25	5-25						
<b>Stopy żaroodporne i stopy tytanu</b>											
S1	Na bazie Fe	675	200	1-8 <sup>1)</sup>	1-8 <sup>1)</sup>						
S2		950	280	1-8 <sup>1)</sup>	1-8 <sup>1)</sup>						
S3	Stopy żaroodporne	850	250								
S4	Na bazie Ni/Co	1200	350								
S5		1100	320								
S6	Czysty tytan	675	200	1-8 <sup>1)</sup>	1-8 <sup>1)</sup>						
S7	Stopy tytanu Stopy α- i β	1250	375								
S8	Stopy β	1400	410								
<b>Materiały twarde</b>											
H1		-	50 HRC								
H2	Stal hartowana	-	55 HRC								
H3		-	60 HRC								
H4	Żeliwo utwardzone i hartowane	-	55 HRC								

<sup>1)</sup> dotyczy gwintowników > M3

HSS	INOX
NAKRÓJ	

GRUPA	MATERIAŁ OBRABIANY	Rm	HB	1,75P	2,25P
<b>Stal</b>					
P1	Stal automatowa	750	220	4-8	4-8
P2	C ≤ 0,55 %	650	190	3-6	3-6
P3	Stal węglowa C > 0,55 %	650	190	3-6	3-6
P4	C ≤ 0,55 %	700	210	2-5	3-6
P5	C > 0,55 %	1000	300	2-5	3-6
P6		600	175		
P7	Stal niskostopowa	1000	300		
P8		1200	380		
P9		1400	420		
P10		700	210	1-3	1-5
P11	Stal wysokostopowa i wysokostopowa stal narzędziowa	1000	300		1-5
P12		1400	420		
P13	Stal nierdzewna Ferrytyczna / Martenzytyczna	700	210		2-6
P14	Martenzytyczna	1100	330		2-6
<b>Stal nierdzewna</b>					
M1	Stal nierdzewna Austenityczna	700	210		2-6
M2	Austenityczna (PH)	1000	300		2-6
M3	Duplex	800	240		
<b>Metale nieżelazne</b>					
N1	Stopy aluminium do obróbki plastycznej (ENAW)	200	-		
N2		500	152		
N3	Stopy aluminium Si ≤ 12%	250	75	10-20	10-20
N4	Stopy aluminium odlewnicze (ENAC) Si ≤ 12%	300	90	10-20	10-20
N5	(ENAC) Si > 12 %	450	130		5-15
N6	Stopy magnezu	250	70		1-5
N7	Czysta miedź, niestopowa	350	100	7-12	10-15
N8	Stopy miedzi długowłórowe	600	180	10-15	10-15
N9	Miedź i jej stopy Stopy miedzi krótkowłórowe (mosiądz, brąz)	400	120		15-25
N10	Wysoka wytrzymałość	1000	300		8-12

**M**

**Gwint metryczny zwykły – ISO DIN-13**

Wymiary sprawdzianów wg. normy ISO 1502

**Przykład oznaczenia:**

24 0152 0080

Sprawdzian pierścieniowy przechodni MSRh M8 6g

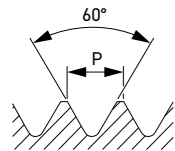

Sprawdzian dwugraniczny MSBg

Sprawdzian przechodni MSRh

Sprawdzian nieprzechodni MSRk

Wymiar	Skok [mm]	Tolerancja Indeks	6H		6G	6g	
			24 0151	24 1151	24 2151	24 0152	24 0154
M1	0,25	0010	•			•	•
M1,1	0,25	0011	•			•	•
M1,2	0,25	0012	•			•	•
M1,4	0,3	0014	•			•	•
M1,6	0,35	0016	•			•	•
M1,7	0,35	0017	•			•	•
M1,8	0,35	0018	•			•	•
M2	0,4	0020	•			•	•
M2,2	0,45	0022	•			•	•
M2,3	0,4	0023	•			•	•
M2,5	0,45	0025	•			•	•
M2,6	0,45	0026	•			•	•
M3	0,5	0030	•	•	•	•	•
M3,5	0,6	0035	•	•	•	•	•
M4	0,7	0040	•	•	•	•	•
M4,5	0,75	0045	•	•	•	•	•
M5	0,8	0050	•	•	•	•	•
M6	1	0060	•	•	•	•	•
M7	1	0070	•	•	•	•	•
M8	1,25	0080	•	•	•	•	•
M9	1,25	0090	•	•	•	•	•
M10	1,5	0100	•	•	•	•	•
M11	1,5	0110	•	•	•	•	•
M12	1,75	0120	•	•	•	•	•
M14	2	0140	•	•	•	•	•
M16	2	0160	•	•	•	•	•
M18	2,5	0180	•	•	•	•	•
M20	2,5	0200	•	•	•	•	•
M22	2,5	0220	•	•	•	•	•
M24	3	0240	•	•	•	•	•
M27	3	0270	•	•	•	•	•
M30	3,5	0300	•	•	•	•	•
M33	3,5	0330	•	•	•	•	•
M36	4	0360	•	•	•	•	•
M39	4	0390	•	•	•	•	•
M42	4,5	0420	•	•	•	•	•
M45	4,5	0450	•	•	•	•	•
M48	5	0480	•	•	•	•	•

**Gwint metryczny zwykły – ISO DIN-13**

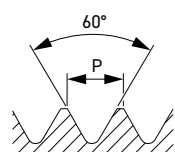

Sprawdzian przechodni MSCh

Sprawdzian nieprzechodni MSCK

Sprawdzian przechodni MSRh

Sprawdzian nieprzechodni MSRk

Wymiar	Skok [mm]	Tolerancja Indeks	6H		6g	6g
			24 0153	24 0155	24 0152	24 0154
M52	5	0520	•	•	•	•
M56	5,5	0560	•	•	•	•
M60	5,5	0600	•	•	•	•
M64	6	0640	•	•	•	•
M68	6	0680	•	•	•	•

**MF**

**Gwint metryczny drobnozwojny – ISO DIN-13**

Wymiary sprawdzianów wg. normy ISO 1502

**Przykład oznaczenia:**

24 0161 2030

Sprawdzian trzpieniowy dwugraniczny MSBg M3x0,35 6H

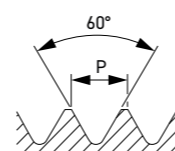

Sprawdzian dwugraniczny MSBg

Sprawdzian przechodni MSRh

Sprawdzian nieprzechodni MSRk

Wymiar [mm]	Skok	Tolerancja Indeks	6H			6g	
			24 0161	24 1161	24 2161	24 0162	24 0164
Skok 0,35 mm							
M3 x 0,35	0,35	2030	•			•	•
M3,5 x 0,35	0,35	2035	•			•	•
M4 x 0,35	0,35	2040	•			•	•
Skok 0,5 mm							
M4 x 0,5	0,5	3040	•			•	•
M4,5 x 0,5	0,5	3045	•			•	•
M5 x 0,5	0,5	3050	•			•	•
M6 x 0,5	0,5	3060	•			•	•
M8 x 0,5	0,5	3080	•			•	•
Skok 0,75 mm							
M6 x 0,75	0,75	4060	•			•	•
M8 x 0,75	0,75	4080	•			•	•
M10 x 0,75	0,75	4100	•			•	•
Skok 1 mm							
M8 x 1	1	5080	•			•	•
M9 x 1	1	5090	•			•	•
M10 x 1	1	5100	•			•	•
M11 x 1	1	5110	•			•	•
M12 x 1	1	5120	•			•	•
M13 x 1	1	5130	•			•	•
M14 x 1	1	5140	•			•	•
M15 x 1	1	5150	•			•	•
M16 x 1	1	5160	•			•	•
M18 x 1	1	5180	•			•	•
M20 x 1	1	5200	•			•	•
M22 x 1	1	5220	•			•	•
M24 x 1	1	5240	•			•	•
M26 x 1	1	5260	•			•	•
M27 x 1	1	5270	•			•	•
M28 x 1	1	5280	•			•	•
M30 x 1	1	5300	•			•	•
Skok 1,25 mm							
M10 x 1,25	1,25	6100	•			•	•
M12 x 1,25	1,25	6120	•			•	•
M14 x 1,25	1,25	6140	•			•	•
Skok 1,5 mm							
M12 x 1,5	1,5	7120	•			•	•
M13 x 1,5	1,5	7130	•			•	•
M14 x 1,5	1,5	7140	•			•	•
M15 x 1,5	1,5	7150	•			•	•
M16 x 1,5	1,5	7160	•			•	•
M18 x 1,5	1,5	7180	•			•	•
M20 x 1,5	1,5	7200	•			•	•
M22 x 1,5	1,5	7220	•			•	•
M24 x 1,5	1,5	7240	•			•	•
M26 x 1,5	1,5	7260	•			•	•
M27 x 1,5	1,5	7270	•			•	•
M28 x 1,5	1,5	7280	•			•	•
M30 x 1,5	1,5	7300	•			•	•
M32 x 1,5	1,5	7320	•			•	•
M33 x 1,5	1,5	7330	•			•	•
M35 x 1,5	1,5	7350	•			•	•
M36 x 1,5	1,5	7360	•			•	•
M38 x 1,5	1,5	7380	•			•	•
M40 x 1,5	1,5	7400	•			•	•
M42 x 1,5	1,5	7420	•			•	•
M45 x 1,5	1,5	7450	•			•	•
M48 x 1,5	1,5	7480	•			•	•



**Gwint metryczny drobnozwojny – ISO DIN-13**

Wymiary sprawdzianów wg. normy ISO 1502

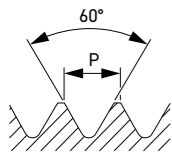
**Przykład oznaczenia:**  
 24 0161 8480  
 Sprawdzian trzpieniowy dwugraniczny MSBg

Wymiar [mm]	Skok	Tolerancja Indeks	6H	6H	6G	6g	6g
			24 0161	24 1161	24 2161	24 0162	24 0164
<b>Skok 2 mm</b>							
M18 x 2	2	8180	•	•	•	•	•
M20 x 2	2	8200	•	•	•	•	•
M22 x 2	2	8220	•	•	•	•	•
M24 x 2	2	8240	•	•	•	•	•
M26 x 2	2	8260	•	•	•	•	•
M27 x 2	2	8270	•	•	•	•	•
M28 x 2	2	8280	•	•	•	•	•
M30 x 2	2	8300	•	•	•	•	•
M32 x 2	2	8320	•	•	•	•	•
M33 x 2	2	8330	•	•	•	•	•
M35 x 2	2	8350	•	•	•	•	•
M36 x 2	2	8360	•	•	•	•	•
M38 x 2	2	8380	•	•	•	•	•
M39 x 2	2	8390	•	•	•	•	•
M40 x 2	2	8400	•	•	•	•	•
M42 x 2	2	8420	•	•	•	•	•
M45 x 2	2	8450	•	•	•	•	•
M48 x 2	2	8480	•	•	•	•	•
<b>Skok 3 mm</b>							
M30 x 3	3	9300	•	•	•	•	•
M33 x 3	3	9330	•	•	•	•	•
M36 x 3	3	9360	•	•	•	•	•
M39 x 3	3	9390	•	•	•	•	•
M40 x 3	3	9400	•	•	•	•	•
M42 x 3	3	9420	•	•	•	•	•
M45 x 3	3	9450	•	•	•	•	•
M48 x 3	3	9480	•	•	•	•	•

**Gwint metryczny drobnozwojny – ISO DIN-13**

Wymiary sprawdzianów wg. normy ISO 1502

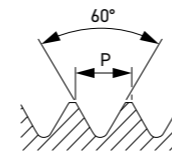
**Przykład oznaczenia:**  
 24 0163 7500  
 Sprawdzian trzpieniowy przechodni MSCh

Wymiar [mm]	Skok	Tolerancja Indeks	6H	6H	6g	6g
			24 0163	24 0165	24 0162	24 0164
<b>Skok 1,5 mm</b>						
M50 x 1,5	1,5	7500	•	•	•	•
M52 x 1,5	1,5	7520	•	•	•	•
M56 x 1,5	1,5	7560	•	•	•	•
M60 x 1,5	1,5	7600	•	•	•	•
M64 x 1,5	1,5	7640	•	•	•	•
M68 x 1,5	1,5	7680	•	•	•	•
M70 x 1,5	1,5	7700	•	•	•	•
M72 x 1,5	1,5	7720	•	•	•	•
M75 x 1,5	1,5	7750	•	•	•	•
M80 x 1,5	1,5	7800	•	•	•	•
<b>Skok 2 mm</b>						
M50 x 2	2	8500	•	•	•	•
M52 x 2	2	8520	•	•	•	•
M56 x 2	2	8560	•	•	•	•
M60 x 2	2	8600	•	•	•	•
M64 x 2	2	8640	•	•	•	•
M68 x 2	2	8680	•	•	•	•
M70 x 2	2	8700	•	•	•	•
M72 x 2	2	8720	•	•	•	•
M75 x 2	2	8750	•	•	•	•
M80 x 2	2	8800	•	•	•	•
<b>Skok 3 mm</b>						
M50 x 3	3	9500	•	•	•	•
M52 x 3	3	9520	•	•	•	•
M56 x 3	3	9560	•	•	•	•
M60 x 3	3	9600	•	•	•	•
M64 x 3	3	9640	•	•	•	•
M68 x 3	3	9680	•	•	•	•
M70 x 3	3	9700	•	•	•	•
M72 x 3	3	9720	•	•	•	•
M75 x 3	3	9750	•	•	•	•
M80 x 3	3	9800	•	•	•	•

**OFERUJEMY TAKŻE:**

- Sprawdziany tłoczkowe do otworów: MSBa H7, H8
  - w średnicach od 1 do 65 mm w tolerancji H7
  - oraz od 3 do 65 mm w tolerancji H8
- Sprawdziany do otworów specjalne
- Sprawdziany tłoczkowe do sprawdzania otworu w gwincie: MSBa pod gwint
  - w wymiarach od M3x0,5 do M22x2,5 mm, gwint metryczny zwykły M, tolerancja 6H
  - oraz M8x0,5 mm do M22x2, gwint metryczny drobnozwojny MF, tolerancja 6H
- Sprawdziany gwintowe trzpieniowe – głębokość 50 mm
  - gwint metryczny zwykły w wymiarach od M3 do M12 i tolerancji 6H
- Sprawdziany gwintowe trzpieniowe i pierścieniowe, gwint rurowy Whitwortha walcowy
  - w wymiarach od G1/8"x28 do G6"x11

## Głowica frezarska TRZPIENIOWA 90° na płytce WNEX 040308



KOD PRODUKTU	ØD (mm)	L1 (mm) głębokość wprowadzenia	L (mm) długość całkowita	d (mm) średnica chwytu	liczba ostrzy
MGGWN020T4009020Z3	20	40	90	20	3
MGGWN025T4410025Z4	25	44	100	25	4
MGGWN032T5011032Z5	32	50	110	32	5
MGGWN020T4015020Z3	20	40	150	20	3
MGGWN025T5017025Z4	25	50	170	25	4
MGGWN032T7019532Z5	32	70	195	32	5

śruba mocująca M 2,5 x 5,5, klucz do śruby mocującej T08, max ap. 4 mm

## Głowica frezarska NASADZANA 90° na płytce WNEX 040308



KOD PRODUKTU	ØD (mm)	L1 (mm) głębokość wprowadzenia	L (mm) długość całkowita	d (mm) średnica otworu	liczba ostrzy
MGGWN032N4004016Z6	32	40	40	16	6
MGGWN040N4004016Z6	40	40	40	16	6
MGGWN050N4004022Z8	50	40	40	22	8
MGGWN063N4004022Z9	63	40	40	22	9

śruba mocująca M 2,5 x 5,5, klucz do śruby mocującej T08, max ap. 4 mm

## Płytki WNEX 040308



KOD PRODUKTU	P	M	K	N	S	H
MGWNEX040308HCP15	Vc: 110-240 m/min fz: 0.1-0.35 mm Ap: 0.5-3.5 mm		Vc: 120-240 m/min fz: 0.1-0.35 mm Ap: 0.5-3.5 mm			
MGWNEX040308HCP25	Vc: 110-240 m/min fz: 0.1-0.35 mm Ap: 0.5-3.5 mm		Vc: 120-240 m/min fz: 0.1-0.35 mm Ap: 0.5-3.5 mm			
MGWNEX040308HCM15	Vc: 110-240 m/min fz: 0.1-0.35 mm Ap: 0.5-3.5 mm	Vc: 50-160 m/min f: 0.12-0.35 mm/t Ap: 0.5-3.5 mm	Vc: 40-100 m/min f: 0.14-0.45 mm/t Ap: 0.3-3.5 mm			
MGWNEX040308HCM25	Vc: 110-240 m/min fz: 0.1-0.35 mm Ap: 0.5-3.5 mm	Vc: 50-160 m/min f: 0.12-0.35 mm/t Ap: 0.5-3.5 mm	Vc: 40-100 m/min f: 0.14-0.45 mm/t Ap: 0.3-3.5 mm			
MGWNEX040308HCN35				Vc: 180-450 m/min f: 0.10-0.45 mm/t Ap: 0.2-3.5 mm		

## Głowica frezarska NASADZANA 90° na płytce APKT 1604

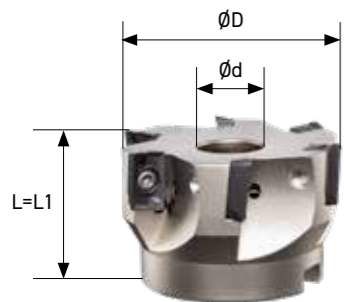

KOD PRODUKTU	ØD (mm)	L1 (mm) głębokość wprowadzenia	L (mm) długość całkowita	d (mm) średnica otworu	liczba ostrzy
MGGAP040N4004016Z4	40	40	40	16	4
MGGAP050N4004022Z5	50	40	40	22	5
MGGAP063N4004022Z6	63	40	40	22	6
MGGAP080N5005027Z7	80	50	50	27	7
MGGAP100N5005032Z8	100	50	50	32	8
MGGAP125N6306340Z9	125	63	63	40	9
MGGAP160N6306340Z10	160	63	63	40	10
MGGAP200N6306360Z12	200	63	63	60	12
MGGAP250N6306360Z16	250	63	63	60	16

śruba mocująca M 4 x 12, klucz do śruby mocującej T15, max ap. 16 mm

## Płytki APKT 1604



KOD PRODUKTU	P	M	K	N	S	H
MGAPKT1604PDRSY1VC35	Vc: 70-190 m/min f: 0.1-0.3 mm/rev. Ap: 1-15 mm		Vc: 70-190 m/min f: 0.1-0.3 mm/rev. Ap: 1-15 mm			

APKT 1604 PDER-S Y1, dedykowana do obróbki mieszanej, typ powłoki: PVD, podstawowe zastosowanie: stal, stal o podwyższonej twardości, żeliwo /obróbka średnia/ P10-25

## Głowica frezarska NASADZANA 90° do obróbki średnio-wykańczającej SERIA MGC01-CW90

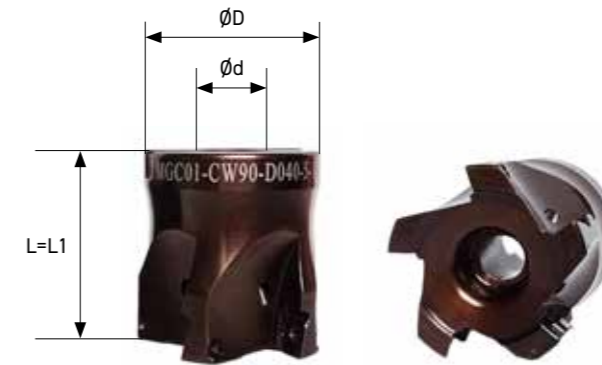

KOD PRODUKTU	ØD (mm)	L1 (mm) głębokość wprowadzenia	L (mm) długość całkowita	d (mm) średnica otworu	liczba ostrzy	ap (mm) głębokość skrawania	wymienna płytka skrawająca
G25 MGC01-CW90-D050-4-22-18	50	40	40	22	4	15	MGCW90-180612M-PM TP0025P*
G25 MGC01-CW90-D040-5-16-11	40	40	40	16	5	8	MGCW90-11T308-PM TP0025P**

\*Klucz do śruby mocującej T15

\*\*Klucz do śruby mocującej T7

## Głowica frezarska TRZPIENIOWA 90° do obróbki średnio-wykańczającej SERIA MGC01-CW90

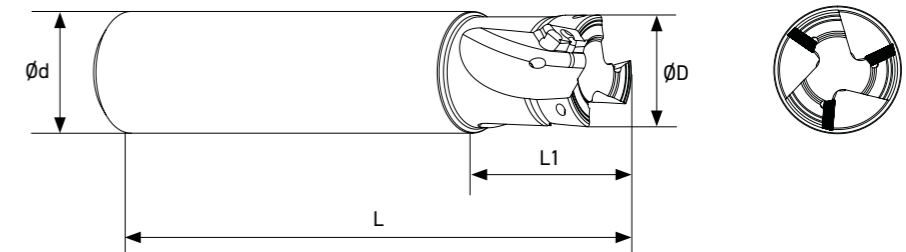

KOD PRODUKTU	ØD (mm)	L1 (mm) głębokość wprowadzenia	L (mm) długość całkowita	d (mm) średnica chwytu	liczba ostrzy	ap (mm) głębokość skrawania	wymienna płytka skrawająca
G25 MGC01-CW90 D025-3-11 L100	25	50	100	25	3	9	MGCW90-11T308-PM TP0025P

klucz do śruby mocującej T7

## Płytki skrawające

KOD PRODUKTU	P	M	K	N	S	H
MGCW90-180612M-PM TP0025P	Vc: 140-260 m/min fn: 0.1-0.5 mm/rev Ap: 1.5-15 mm	Vc: 140-260 m/min fn: 0.1-0.5 mm/rev Ap: 1.5-15 mm			Vc: 140-260 m/min fn: 0.1-0.5 mm/rev Ap: 1.5-15 mm	
MGCW90-11T308-PM TPTP0025P	Vc: 140-260 m/min fn: 0.1-0.5 mm/rev Ap: 1.5-7.0 mm	Vc: 140-260 m/min fn: 0.1-0.5 mm/rev Ap: 1.5-7.0 mm			Vc: 140-260 m/min fn: 0.1-0.5 mm/rev Ap: 1.5-7.0 mm	



## TPKN

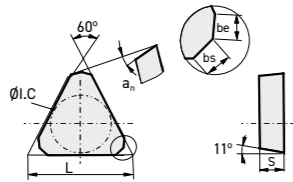

KOD PRODUKTU	nazwa	L	l.C	S	be	bs	an
MGTPKN1603HCP20/M20	Płytki TPKN1603PDSR HC P20/M20	16.5	9.525	3.18	1,0	1,2	11°

**P**  $V_c: 160 - 190 \text{ m/min}$   
 $f_z: 0,1 - 0,18 \text{ mm/r}$

**M**  $V_c: 110 - 130 \text{ m/min}$   
 $f_z: 0,07 - 0,13 \text{ mm/r}$

MGTPKN2204HCP20/M20	Płytki TPKN2204PDSR HC P20/M20	22	12.7	4.76	1,4	0,7	11°
---------------------	--------------------------------	----	------	------	-----	-----	-----

**P**  $V_c: 160 - 190 \text{ m/min}$   
 $f_z: 0,11 - 0,21 \text{ mm/r}$

**M**  $V_c: 110 - 130 \text{ m/min}$   
 $f_z: 0,08 - 0,15 \text{ mm/r}$

HC\*

P M K N S H

HC\*

P M K N S H

## SPKN

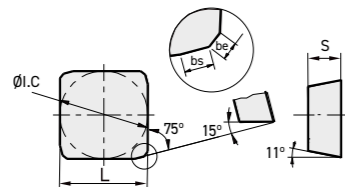

KOD PRODUKTU	nazwa	L	l.C	S	be	bs
MGSPKN1203HWP30	Płytki SPKN1203EDSR HW P30	12.7	12.7	3.18	1,0	1,4

**P**  $V_c: 20 - 90 \text{ m/min}$   
 $f_z: 0,1 - 0,18 \text{ mm/r}$

**K**  $V_c: 20 - 90 \text{ m/min}$   
 $f_z: 0,1 - 0,19 \text{ mm/r}$

MGSPKN1203HCP20/M20	Płytki SPKN1203EDSR HC P20/M20	12.7	12.7	3.18	1,0	1,4
---------------------	--------------------------------	------	------	------	-----	-----

**P**  $V_c: 160 - 190 \text{ m/min}$   
 $f_z: 0,1 - 0,18 \text{ mm/r}$

**M**  $V_c: 110 - 130 \text{ m/min}$   
 $f_z: 0,07 - 0,13 \text{ mm/r}$

MGSPKN1504HCP25/M25	Płytki SPKN1504EDSR HC P25/M25	15.875	15.875	4.76	1,0	1,4
---------------------	--------------------------------	--------	--------	------	-----	-----

**P**  $V_c: 130 - 160 \text{ m/min}$   
 $f_z: 0,11 - 0,21 \text{ mm/r}$

**M**  $V_c: 100 - 130 \text{ m/min}$   
 $f_z: 0,08 - 0,15 \text{ mm/r}$

HW\*

P M K N S H

HC\*

P M K N S H

HC\*

P M K N S H

## TPUN

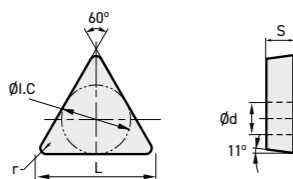

KOD PRODUKTU	nazwa	L	l.C	S	r
MGTPUN160304HCP25/M25	Płytki TPUN160304 HC P25/M25	16.5	9.525	3.18	0,4

**P**  $V_c: 130 - 160 \text{ m/min}$   
 $f_z: 0,08 - 0,16 \text{ mm/r}$

**M**  $V_c: 100 - 130 \text{ m/min}$   
 $f_z: 0,06 - 0,12 \text{ mm/r}$

MGTPUN160308HCP25/M25	Płytki TPUN160308 HC P25/M25	16.5	9.525	3.18	0,8
-----------------------	------------------------------	------	-------	------	-----

**P**  $V_c: 130 - 160 \text{ m/min}$   
 $f_z: 0,1 - 0,18 \text{ mm/r}$

**M**  $V_c: 100 - 130 \text{ m/min}$   
 $f_z: 0,07 - 0,13 \text{ mm/r}$

MGTPUN220408HCP25/M25	Płytki TPUN220408 HC P25/M25	22	12.7	4.76	0,8
-----------------------	------------------------------	----	------	------	-----

**P**  $V_c: 130 - 160 \text{ m/min}$   
 $f_z: 0,11 - 0,21 \text{ mm/r}$

**M**  $V_c: 100 - 130 \text{ m/min}$   
 $f_z: 0,08 - 0,15 \text{ mm/r}$

HC\*

P M K N S H

HC\*

P M K N S H

HC\*

P M K N S H

HC\* - węgiel pokrywany  
HW\* - węgiel bez pokrycia

## UŁATWIENIA DLA UŻYTKOWNIKA:

- Możliwość konfiguracji rozmiarów przegródek i szuflad zgodnie z potrzebami.
- Duży ekran pozwalający na szybką i łatwą identyfikację towarów.
- Wbudowany skaner do kodów kreskowych i QR kodów znacznie przyspieszający pracę i eliminujący pomyłki.
- Jednolity system do wszystkich rodzajów szaf, dzięki któremu w łatwy i intuicyjny sposób pobierzesz narzędzia.
- System współpracujący z ERP.

## ZYSKUJESZ:

- Dostępność narzędzi w trybie 24/7.
- Zmniejszenie kosztów składowania i zarządzania narzędziami.
- Obniżenie zużycia narzędzi przynajmniej o 30%.
- Eliminację przestoju produkcyjnych.
- Przejrzystość kosztów - raporty w trybie 24/7, także zdalnie.



SZCZĘKA GÓRNA MIĘKKA

Wykonanie stal

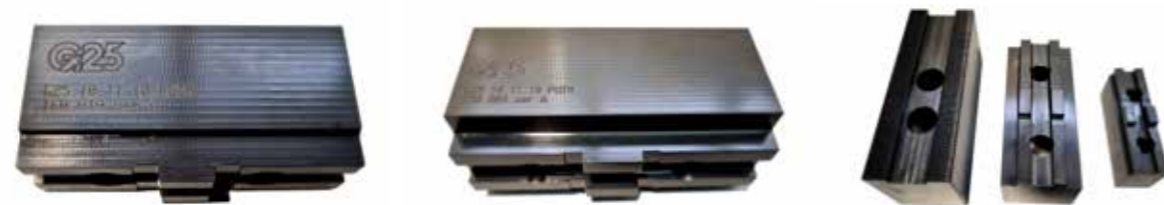
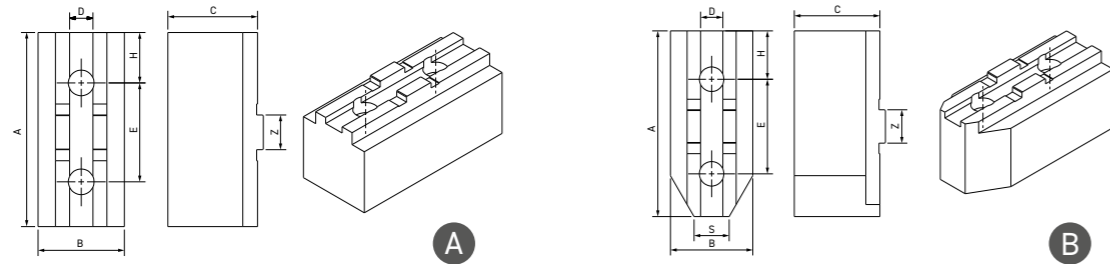

Typ uchwytu BISON PUTM	index	A	B	C	D	E	śruby	H	Z	S	wersja
3105 - 315 <sup>2)</sup> 32** - 315 <sup>3)</sup> 35** - 315 <sup>3)</sup> 36** - 315 <sup>4)</sup> 37** - 315 <sup>4)</sup> 38** - 315 <sup>4)</sup>	G25.10.11.10.PUTM. 315.0014.wer. ...	120	49	52	12,7	63,5	M12	30,8	19,04	-	A
		120	49	52	12,7	63,5	M12	30,8	19,04	20	B
	G25.10.11.10.PUTM. 250.008.wer. ...	106	47	46	12,7	54	M12	27,5	19,04	-	A
		106	47	46	12,7	54	M12	27,5	19,04	20	B
3105 - 200 <sup>2)</sup> 32** - 200 <sup>3)</sup> 35** - 200 <sup>3)</sup> 36** - 200 <sup>4)</sup> 37** - 200 <sup>4)</sup> 38** - 200 <sup>4)</sup>	G25.10.11.10.PUTM. 200.009.wer. ...	90	39	38,5	7,95	44,5	M10	24,1	12,69	-	A
		90	39	38,5	7,95	44,5	M10	24,1	12,69	16	B
	G25.10.11.10.PUTM. 160.010.wer. ...	78	24	36,5	7,95	38,1	M10	21,3	12,69	-	A
		78	24	36,5	7,95	38,1	M10	21,3	12,69	12	B

<sup>2)</sup> 2 szczękowy  
<sup>3)</sup> 3 szczękowy  
<sup>4)</sup> 4 szczękowy  
<sup>4)</sup> 6 szczękowy

SZCZĘKA GÓRNA MIĘKKA

Wykonanie aluminium

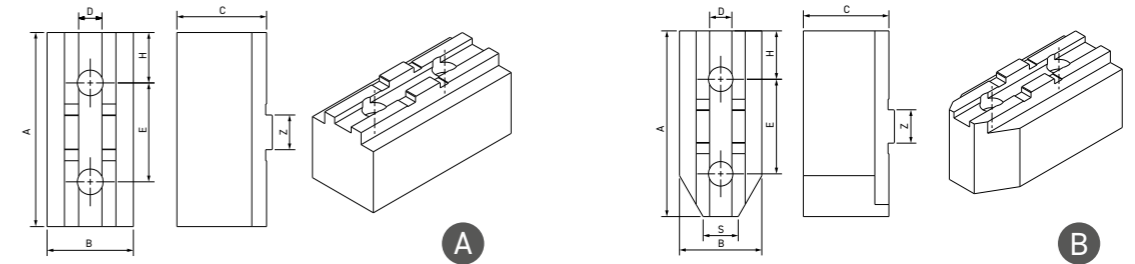

Typ uchwytu BISON PUTM	index	A	B	C	D	E	śruby	H	Z	S	wersja
3105 - 315 <sup>2)</sup> 32** - 315 <sup>3)</sup> 35** - 315 <sup>3)</sup> 36** - 315 <sup>4)</sup> 37** - 315 <sup>4)</sup> 38** - 315 <sup>4)</sup>	G25.10.11.10.PUTM. 315.0014.wer. ...	120	49	52	12,7	63,5	M12	30,8	19,04	-	A
		120	49	52	12,7	63,5	M12	30,8	19,04	20	B
	G25.10.11.10.PUTM. 250.008.wer. ...	106	47	46	12,7	54	M12	27,5	19,04	-	A
		106	47	46	12,7	54	M12	27,5	19,04	20	B
3105 - 200 <sup>2)</sup> 32** - 200 <sup>3)</sup> 35** - 200 <sup>3)</sup> 36** - 200 <sup>4)</sup> 37** - 200 <sup>4)</sup> 38** - 200 <sup>4)</sup>	G25.10.11.10.PUTM. 200.009.wer. ...	90	39	38,5	7,95	44,5	M10	24,1	12,69	-	A
		90	39	38,5	7,95	44,5	M10	24,1	12,69	16	B
	G25.10.11.10.PUTM. 160.010.wer. ...	78	24	36,5	7,95	38,1	M10	21,3	12,69	-	A
		78	24	36,5	7,95	38,1	M10	21,3	12,69	12	B

<sup>2)</sup> 2 szczękowy  
<sup>3)</sup> 3 szczękowy  
<sup>4)</sup> 4 szczękowy  
<sup>4)</sup> 6 szczękowy



## SZCZĘKA GÓRNA MIĘKKA

uzębienie 1,5 mm x 60 stopni

Wykonanie stal

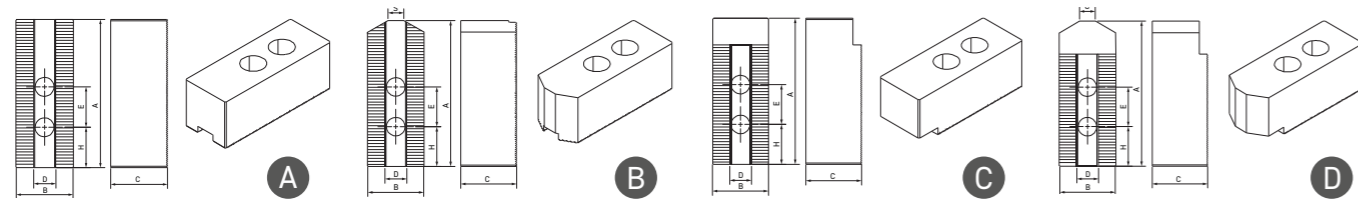

TYP UCHWYTU	index	A	B	C	D	E	śruby	H	S	wersja
BISON 2404 - 315 K 2405 - 315 41 K 2405 - 315 110 K	G25.10.11.10.2404/5. 315.001.wer. ...	129	48	60	21	30	M16	39	—	A
		129	48	60	21	30	M16	39	12	B
		129	48	60	21	30	M16	39	—	C
		129	48	60	21	30	M16	39	12	D
BISON 2404 - 250 K 2405 - 250 75 K 2405 - 250 81 K	G25.10.11.10.2404/5. 250.002.wer. ...	110	39	42	16	30	M12	30	—	A
		110	39	42	16	30	M12	30	12	B
		110	39	42	16	30	M12	30	—	C
		110	39	42	16	30	M12	30	12	D
BISON 2404 - 200 K 2404 - 200 - 52 K 2405 - 200 - 66 K	G25.10.11.10.2404/5. 200.003.wer. ...	95	34	60	14	25	M12	24	—	A
		95	34	60	14	25	M12	24	5	B
		95	34	60	14	25	M12	24	—	C
		95	34	60	14	25	M12	24	5	D
BISON 2404 - 160 K 2405 - 160 45 K 2405 - 160 53 K	G25.10.11.10.2404/5. 160.004.wer. ...	72	34	60	12	20	M10	15	—	A
		72	34	60	12	20	M10	15	12	B
		72	34	60	12	20	M10	15	—	C
		72	34	60	12	20	M10	15	12	D
BISON 2404 - 160 K 2404 - 160 - 45 K 2405 - 160 - 53 K	G25.10.11.10.2404/5. 160.005.wer. ...	75	30	30	12	20	M10	15	—	A
		75	30	30	12	20	M10	15	13	B
		75	30	30	12	20	M10	15	—	C
		75	30	30	12	20	M10	15	13	D
BISON 2404 - 135 K 2405 - 135K - 34 K	G25.10.11.10.2404/5. 135.006.wer. ...	55	24	32	10	14	M8	13	—	A
		55	24	32	10	14	M8	13	4	B
		55	24	32	10	14	M8	13	—	C
		55	24	32	10	14	M8	13	4	D
KITAGAWA BB 210	G25.20.11.10.BB. 210.007.wer. ....	110	42	60	16	30	M12	30	—	A
		110	42	60	16	30	M12	40	12	B
		130	42	80	16	30	M12	25	—	A*

## SZCZĘKA GÓRNA MIĘKKA

uzębienie 1,5 mm x 60 stopni

Wykonanie aluminium

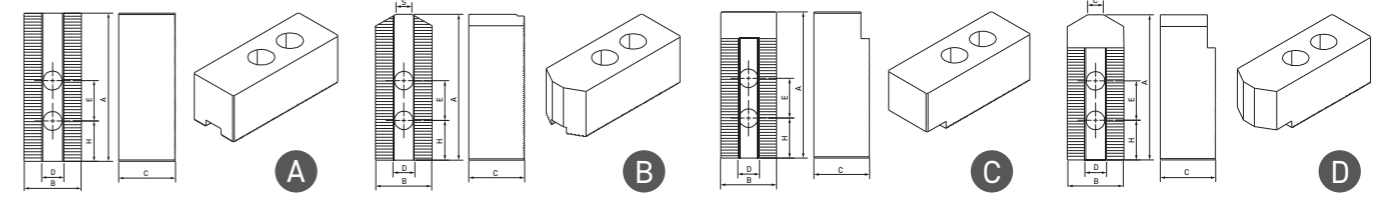

TYP UCHWYTU	index	A	B	C	D	E	śruby	H	S	wersja
BISON 2404 - 315 K 2405 - 315 41 K 2405 - 315 110 K	G25.10.21.2404/5. 315.001.wer. ...	129	48	60	21	30	M16	39	—	A
		129	48	60	21	30	M16	39	12	B
		129	48	60	21	30	M16	39	—	C
		129	48	60	21	30	M16	39	12	D
BISON 2404 - 250 K 2405 - 250 75 K 2405 - 250 81 K	G25.10.21.2404/5. 250.002.wer. ...	110	39	42	16	30	M12	30	—	A
		110	39	42	16	30	M12	30	12	B
		110	39	42	16	30	M12	30	—	C
		110	39	42	16	30	M12	30	12	D
BISON 2404 - 200 K 2404 - 200 - 52 K 2405 - 200 - 66 K	G25.10.21.2404/5. 200.003.wer. ...	95	34	60	14	25	M12	24	—	A
		95	34	60	14	25	M12	24	5	B
		95	34	60	14	25	M12	24	—	C
		95	34	60	14	25	M12	24	5	D
BISON 2404 - 160 K 2405 - 160 45 K 2405 - 160 53 K	G25.10.21.2404/5. 160.004.wer. ...	72	34	60	12	20	M10	15	—	A
		72	34	60	12	20	M10	15	12	B
		72	34	60	12	20	M10	15	—	C
		72	34	60	12	20	M10	15	12	D
BISON 2404 - 160 K 2404 - 160 - 45 K 2405 - 160 - 53 K	G25.10.21.2404/5. 160.005.wer. ...	75	30	30	12	20	M10	15	—	A
		75	30	30	12	20	M10	15	13	B
		75	30	30	12	20	M10	15	—	C
		75	30	30	12	20	M10	15	13	D
BISON 2404 - 135 K 2405 - 135K - 34 K	G25.10.21.2404/5. 135.006.wer. ...	55	24	32	10	14	M8	13	—	A
		55	24	32	10	14	M8	13	4	B
		55	24	32	10	14	M8	13	—	C
		55	24	32	10	14	M8	13	4	D
KITAGAWA BB 210	G25.20.21.BB. 210.007.wer. ....	110	42	60	16	30	M12	30	—	A
		110	42	60	16	30	M12	40	12	B
		130	42	80	16	30	M12	25	—	A*

## TORBA MONTERSKA CZARNA Nr 1 i 2



**MATERIAŁ:** skóra dwoina kryta

Torba monterska wykonana ze skóry dwoiny krytej. Połączenia elementów torby za pomocą mocnych nici, dodatkowo wzmocniana nitami. Torba posiada rączkę oraz pas nośny z regulacją długości. Wewnątrz uchwyt do mocowania narzędzi oraz kieszeń zapinana na zatrzask. Idealna dla monterów, elektryków, dekarzy i innych fachowców.

### WYMIARY ZEWNĘTRZNE:

Torba czarna NR 1 MGTMS-NR1CZARNA	Torba czarna NR 2 MGTMS-NR2CZARNA
szerokość 36 cm	szerokość 40 cm
głębokość 15 cm	głębokość 16 cm
wysokość 24 cm + 5 cm rączka	wysokość 28 cm + 5 cm rączka

## TORBA MONTERSKA JASNA Nr 1 i 2



**MATERIAŁ:** skóra juchtowa żywicowana

Torba monterska wykonana ze skóry juchtowej. Połączenia elementów torby za pomocą mocnych nici, dodatkowo wzmocniana nitami. Torba posiada rączkę oraz pas nośny z regulacją długości. Wewnątrz uchwyt do mocowania narzędzi oraz kieszeń zapinana na zatrzask. Idealna dla monterów, elektryków, dekarzy i innych fachowców.

### WYMIARY ZEWNĘTRZNE:

Torba jasna NR 1 MGTMS-NR1JASNA	Torba jasna NR 2 MGTMS-NR2JASNA
szerokość 36 cm	szerokość 40 cm
głębokość 15 cm	głębokość 16 cm
wysokość 24 cm + 5 cm rączka	wysokość 28 cm + 5 cm rączka

## TORBA MONTERSKA CZARNA Nr 3



**MATERIAŁ:** skóra dwoina kryta

Torba monterska wykonana ze skóry dwoiny krytej. Połączenia elementów torby za pomocą mocnych nici, dodatkowo wzmocniana nitami. Torba posiada rączkę oraz pas nośny z regulacją długości. Wewnątrz uchwyt do mocowania narzędzi oraz kieszeń zapinana na zatrzask.

Torba posiada z przodu dodatkową kieszeń oraz 6 nówek. Idealna dla monterów, elektryków, dekarzy i innych fachowców.

### WYMIARY ZEWNĘTRZNE:

Torba czarna NR 3 MGTMS-NR3CZARNA
szerokość 40 cm
głębokość 16 cm + 5 cm przednia kieszeń
wysokość 28 cm + 5 cm rączka

## TORBA MONTERSKA JASNA Nr 3



**MATERIAŁ:** skóra juchtowa żywicowana

Torba monterska wykonana ze skóry juchtowej. Połączenia elementów torby za pomocą mocnych nici, dodatkowo wzmocniana nitami. Torba posiada rączkę oraz pas nośny z regulacją długości. Wewnątrz uchwyt do mocowania narzędzi oraz kieszeń zapinana na zatrzask.

Torba posiada z przodu dodatkową kieszeń oraz 6 nówek. Idealna dla monterów, elektryków, dekarzy i innych fachowców.

### WYMIARY ZEWNĘTRZNE:

Torba jasna NR 3 MGTMS-NR3JASNA
szerokość 40 cm
głębokość 16 cm + 5 cm przednia kieszeń
wysokość 28 cm + 5 cm rączka

## CERTYFIKAT OSA



KOD PRODUKTU	nazwa	wymiary (mm)	max prędkość robocza	dopuszczalna liczba obrotów	opakowanie sztuki
66252846470	Ściernica metal/inox 125x1.0x22.23	125x1x22.23	12 250	80 m/s	25
66252847052	Ściernica metal/inox 125x6,4x22,23	125x6,4x22,23	12 250	80 m/s	10
78072723122	Ściernica listkowa metal/inox 125x22,23 P40	125x22,23	12 250	80 m/s	10
78072723123	Ściernica listkowa metal/inox 125x22,23 P60	125x22,23	12 250	80 m/s	10
78072749625	Ściernica listkowa metal/inox 125x22,23 P80	125x22,23	12 250	80 m/s	10
78072749630	Ściernica listkowa metal/inox 125x22,23 P120	125x22,23	12 250	80 m/s	10

## RĘKAWICE SPAWALNICZE



KOD PRODUKTU	nazwa
S-GLOVE G25 STRONG - Ż	Rękawice spawalnicze żółte
S-GLOVE G25 STRONG - N	Rękawice spawalnicze niebieskie
S-GLOVE G25 STRONG - RO	Rękawice robocze - ochronne

Rękawice spełniają wysokie kryteria jakościowe oraz posiadają niezbędne atesty i certyfikaty

## DOSTARCZAMY ROZWIĄZANIA DO:

### Ochrony pracowników i poprawy bezpieczeństwa pracy poprzez usuwanie mgły olejowej, oparów emulsji, oparów i zadymień

Mgła olejowa w powietrzu może prowadzić do szeregu problemów zdrowotnych, w tym chorób układu oddechowego i skóry pracowników. Mgła olejowa może również stanowić zagrożenie bezpieczeństwa pracy – zaolejone podłogi stanowią ryzyko poślizgnięcia się, a nagromadzenie się warstwy olejowej np. w przewodach wentylacyjnych może stanowić zagrożenie pożarowe. Prowadzi ona również do uszkodzenia czułych urządzeń elektrycznych, powodując niepotrzebne przestoje w produkcji. Dlatego też tak istotne jest by usunąć ją u źródła powstawania. W naszej ofercie znajdują Państwo urządzenia do usuwania mgły olejowej, oparów emulsji i oparów powstających podczas procesów produkcyjnych.

## ZAPEWNIAMY PROFESJONALNY PROJEKT, MONTAŻ ORAZ SERWIS



[www.filtracjamgloyolejowej.pl/](http://www.filtracjamgloyolejowej.pl/)



[www.imponar.pl/produkty/firma/absolent/](http://www.imponar.pl/produkty/firma/absolent/)



### Generowanie oszczędności dzięki wprowadzeniu filtracji i recyklingu cieczy przemysłowych



[www.filtracjacieczypremyslowych.pl/c/](http://www.filtracjacieczypremyslowych.pl/c/)

- urządzenia czyszczące – filtrujące idealnie nadają się do okresowego czyszczenia wnętrza maszyn i zbiorników, zbierania cząstek stałych, szlamu szlifierskiego czy oczyszczania chłodziw i olejów chłodząco smarujących
- wirówki mobilne to urządzenia służące do oczyszczania olejów, chłodziw i środków myjących
- systemy ultrafiltracyjne służące do kilkukrotnego wydłużenia okresu użycia drogich i skomplikowanych chemicznie cieczy myjących
- wyparki, których obszarem zastosowania są kąpiele myjące i płuczące, wstępna obróbka lakiernicza, oczyszczanie ścieków i odtłuszczenie, umożliwiają oddzielenie zanieczyszczeń od cieczy na bazie wody

## Wydajny recykling i oczyszczanie cieczy procesowych przy użyciu technologii wyparki MKR

Wydajne oczyszczanie ścieków przy użyciu technologii wyparki MKR



100 €/t  
przez zewnętrzną firmę utylizacyjną



ok. 10 €/t  
z technologią odparowania MKR

Idealne rozwiązanie przy maszynach obróbczych i myjkach przemysłowych – podłączenie w by-pass!



w przeszłości  
wymagające i czasochłonne



dziś  
rozwiązanie ekonomiczne i łatwe w obsłudze

**FRIESS**<sup>GmbH</sup>



[www.imponar.pl/produkty/firma/friess/](http://www.imponar.pl/produkty/firma/friess/)

Skimmery olejowe służące do odtłuszczenia wody, oczyszczania ścieków, odolejania emulsji/chłodziw, usuwania oleju z kąpiele odtłuszczeniowych w myjkach przemysłowych czy też wspomaganie utylizacji cieczy przemysłowych.

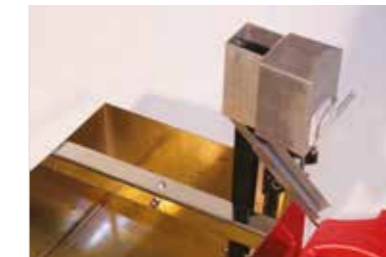

Elektrostatyczne urządzenia do oczyszczania oleju hydraulicznego bez dodatków stałych Friess – EFC usuwają z oleju cząsteczki zanieczyszczeń wielkości od 0,05 µm. Dodatkowy element odwadniający redukuje zawartość niezwiązanej wody do poziomu ok. 100 ppm.

Olej hydrauliczny oczyszczony za pomocą urządzenia Friess EFC nie będzie wymagał wymiany przez okres podany przez producentów olejów na ich specyfikacjach zakupowych.

Koszt oleju zmniejsza się o 90%, a awaryjność urządzeń hydraulicznych o 70%. Amortyzacja urządzenia Friess EFC osiągnięta jest w ciągu 6–12 miesięcy w zależności od ilości.







G25 | DC10



G25 | VC10



G25 | SDN10



G25 | IP67 ZD10

**IP67**

SWISS TECHNOLOGY

## SUWMIARKI/DIN 862

KOD KATALOGOWY	zakres (mm)	dokładność (mm)	odczyt	świadcstwo kalibracji	UWAGI
G25 SDN 10	0-150	0.01	cyfrowy	V	
G25 SDN 20	0-200	0.01	cyfrowy	V	
G25 SDN 30	0-300	0.01	cyfrowy	V	
G25 IP 67 ZD10	0-150	0.01	cyfrowy	V	WODOODPORNIA
G25 IP 67 ZD20	0-200	0.01	cyfrowy	V	WODOODPORNIA
G25 IP 67 ZD30	0-300	0.01	cyfrowy	V	WODOODPORNIA
G25 VC 10	0-150	0.02	noniuszowy	V	
G25 VC 20	0-200	0.02	noniuszowy	V	
G25 VC 30	0-300	0.02	noniuszowy	V	
G25 DC10	0-150	0.02	cyfrowy/zegarowa	V	WSTRZAŚOODPORNIA



G25 | 306A



G25 | 306L



G25 | K02



G25 | K17F

## CZUJNIKI ZEGAROWE

KOD KATALOGOWY	zakres (mm)	rozdzielczość (mm)	stopniowanie	świadcstwo kalibracji	UWAGI
G25 K01	0-10	0.01	0-50-0	V	WSTRZAŚOODPORNY
G25 K02	0-10	0.01	0-100	V	WSTRZAŚOODPORNY
G25 K17S	0-1	0.001	0-100-0	V	
G25 306A	0.8	0.01	0-40-0	V	
G25 308A	0.2	0.002	0-10-0	V	
G25 306L	0.8	0.01	0-40-0	V	



G25 | MMC25



G25 | MMC50



G25 | MMC75



G25 | MMC100

## MIKROMETRY ZEWNĘTRZNE

KOD KATALOGOWY	zakres (mm)	dokładność	odczyt	świadcstwo kalibracji
G25 MMC25-1	0-25	0.001	analogowy	V
G25 MMC25	0-25	0.01	analogowy	V
G25 MMC50	25-50	0.01	analogowy	V
G25 MMC75	50-75	0.01	analogowy	V
G25 MMC 100	75-100	0.01	analogowy	V



G25 | K703



G25 | K803

## ŚREDNICÓWKI ZEGAROWE

KOD KATALOGOWY	zakres (mm)	dokładność	stopniowanie	świadcstwo kalibracji
G25 K703	18-55	0.01	0-50-0	V
G25 K803	50-150	0.01	0-50-0	V

## STATYW MAGNETYCZNY

KOD KATALOGOWY

G25 MSF



### WYSOKOŚCIOMIERZ QM-Height

- Łatwy w obsłudze
- Wyposażony w funkcje eksportu danych; przez łącze DIGMATIC, USB lub bezprzewodowo (U-WAVE)



518-244

518-246

### WYSOKOŚCIOMIERZ 2D LINEAR HEIGHT LH-600 E/EG

- Przyjazny dla użytkownika panel sterowania kolorowym wyświetlaczem LCD
- Świetna dokładność
- Predefiniowane funkcje pomiarowe
- Programy części
- Statystyka



518-351D-21

518-352D-21

### WYSOKOŚCIOMIERZ QM-Height I WYSOKOŚCIOMIERZ 2D LINEAR HEIGHT LH-600 E/EG

KOD KATALOGOWY	zakres (mm)	oznaczenie	dokładność (μm)	rozdzielczość (mm)	poduszka powietrzna	opcjonalne akcesoria
518-240	0-350	Wysokościomierz QM-Height	±(2,4+2,1/600)	0,001		kabel DIGMATIC (1m), kabel DIGMATIC (2m), kabel USB Input Tool Direct (2m), zestaw montażowy uchwytu U-WAVE, zasilacz AC 6V DC, 2A
518-242	0-600	Wysokościomierz QM-Height	±(2,4+2,1/600)	0,001		
518-244	0-350	Wysokościomierz QM-Height	±(2,4+2,1/600)	0,001	V	
518-246	0-600	Wysokościomierz QM-Height	±(2,4+2,1/600)	0,001	V	zestaw końcówek, DMX-0-1 USB (HID) interfejs do wysyłania danych pomiarowych do Excela, kabel RS232-C do podłączenia wysokościomierzy do interfejsu
518-351D-21	0-600	Wysokościomierz Linear Height LH-600 E 2D	±(1,1+0,6/600)	0,0001	V	
518-352D-21*	0-600	Wysokościomierz Linear Height LH-600 EG 2D	±(1,1+0,6/600)	0,0001	V	

#### Przykładowe akcesoria:

901-125 płyta granitowa 1000 x 630 x 100 mm; DIN 876; klasa 0  
901-933 podstawa do płyty granitowej do 901-125

\*z uchwytem Power Grip

### U-WAVE I U-WAVE FIT - SYSTEM BEZPRZEWODOWEJ TRANSMISJI DANYCH

- Zasięg do 20 m
- System bezprzewodowy
- Łatwy eksport danych
- Nadajnik dostępny w wersji IP67
- Niewielkie zużycie energii



02AZD810D

- Do mikrometrów U-WAVE-TM z adapterem



293-230-30

264-622  
02AZF310

- Do suwmiarek U-WAVE-TC z adapterem



500-161-30

264-620  
02AZF300

- Do różnych przyrządów pomiarowych U-WAVE-T z kablem łączącym

02AZD730G  
02AZD790A

543-390B

570-312

468-162

178-560-11D

KOD KATALOGOWY	oznaczenie	przyrząd pomiarowy	wskaźnik odbioru danych
02AZD810D	Odbiornik nadajników U-WAVE (do 100 urządzeń)		
264-623	U-WAVE-TM	Mikrometr odporny na płyn obróbkowy (IP65)	Brzęczyk/LED
264-621	U-WAVE-TC	Suwmiarka/ suwmiarka standardowa 100,150, 200, 300, IP67	Brzęczyk/LED
02AZF310	Adapter	Suwmiarka IP67/ Mikrometr odporny na płyn obróbkowy IP65	
02AZD730G	Nadajnik U-WAVE-T	np. do suwmiarek z włókna węglowego, Holtest, wysokościomierzy cyfrowych, Borematic, SurfTest, Quickmike	LED
02AZD790F	Kabel łączący	np. do czujników cyfrowych (ID-C, ID-S, ID-U), wysokościomierzy, Borematic	



### MiSTAR 555

współrzędnościowa maszyna pomiarowa CNC  
przeznaczona do pracy na hali produkcyjnej

MiSTAR 555 to współrzędnościowa maszyna pomiarowa CNC przeznaczona do pracy na hali produkcyjnej. Charakteryzuje się wysoką odpornością na nieprzyjemne warunki środowiskowe i małymi wymiarami. Dzięki wydajności, która odróżnia ją od konwencjonalnych współrzędnościowych maszyn pomiarowych, MiSTAR 555 gwarantuje zwiększenie produktywności.

- Wysoka dokładność, duża prędkość i duże przyspieszenie
- Czujniki temperatury do kompensacji maszyny i przedmiotu obrabianego od 10° do 40°C oraz monitorowania temperatury otoczenia
- Liniaty ABS zapewniają wysoką odporność na warunki środowiskowe i oszczędza czas przy uruchomieniu, ponieważ zerowanie nie jest konieczne
- Nowy sterownik UC480 obsługujący funkcję monitorowania serwisowego



357-305

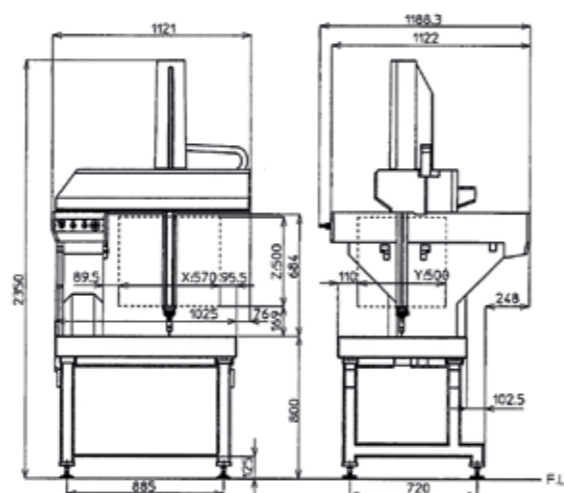

KOD KATALOGOWY	zakres (mm)	dokładność (mm)	prędkość przejazdu (mm/s)	temperatura pracy (°C)	raport zasilania	waga (kg)	wysokość (mm)
357-305	570x500x500	±(2,2+0,3l/100)	606	10-40	raport podsumowujący badania UN 38.3	120	660

### SZKOLENIA

- Rysunek techniczny
- Systemy jakości
- Wzorcowanie i sprawdzanie aparatury kontrolno-pomiarowej (teoria i praktyka)
- Metrologia warsztatowa (teoria i praktyka)
- Statystyczna kontrola procesu
- Pomiary na maszynach pomiarowych (systemy Mcosmos, Modus)
- Systemy zbierania i monitorowania statystycznego danych z procesów produkcyjnych i jakościowych



### WDROŻENIA

- Systemy monitorowanie pracy maszyn OEE
- Dobór i projektowanie wyposażenia do laboratoriów i izb pomiarowych
- Konstrukcja i wykonanie oprzyrządowania produkcyjnego oraz sprawdzianów
- Optymalizacja i usprawnienia procesów technologicznych i produkcyjnych
- Przygotowania firm do wdrożeń systemów jakości (ISO9001; AS9100)



### POMIARY

Realizacja pomiarów produktów klienta z użyciem nowoczesnych technik pomiarowych:

- współrzędnościowa maszyna pomiarowa
- konturograf
- profilografometr
- twardościomierz
- precyzyjny wysokościomierz

Posiadamy zdolność wykonywania pomiarów dla tolerancji 0.003 mm



### WZORCOWANIA

- Posiadamy certyfikację w tym zakresie potwierdzoną certyfikatem ISO 9001
- Wszystkie usługi realizowane są zgodnie z wymaganiami normy ISO 17025
- Usługi dla ręcznych przyrządów pomiarowych
- Usługi dla stanowisk, systemów pomiarowych
- Pełny nadzór nad bazą i czasookresami wzorcowań klienta





## NASZE PRODUKTY

Wiertła  
Frezy VHM  
Nawiertaki  
Pogłębiacze stożkowe  
Rozwiertaki  
Gwintowniki maszynowe  
Pilniki obrotowe  
Materiały ściernie  
Płytki wieloostrzowe  
Głowice frezarskie  
Technika pomiarowa

## USŁUGI

Filtracja  
Szafy wydające  
Znakowanie laserowe  
Produkcja krótko i średnio-seryjna  
Narzędzia specjalne  
Profesjonalne usługi pomiarowe